

Voici notre service de personnalisation:

1. Changer la longueur
2. Changer la couleur
3. Polissage
4. Sablage
5. brosse feuille d'aluminium
- Trou 6. Couper
7. Laser carve
8. étiquette PVC
9. plaque acrylique
10. écran

Utilisez:

Il est largement utilisé dans l'électronique, l'instrumentation, l'automatisation, la communication, unit d'alimentation, projets d'étudiants, amplificateurs, équipement de soins de santé, de l'équipement de test et de mesure, contrôle industriel, les appareils de périphériques et d'interfaces, boîtes de commutation.

Attention:

Bienvenue à nous contacter pour plus de détails et des citations de notre enceinte, votre demande sera sûrement obtenir une réponse rapide en 24 heures. :-)

SZOMK

**Customizable
Cutout, sticker
Silkscreen, color**

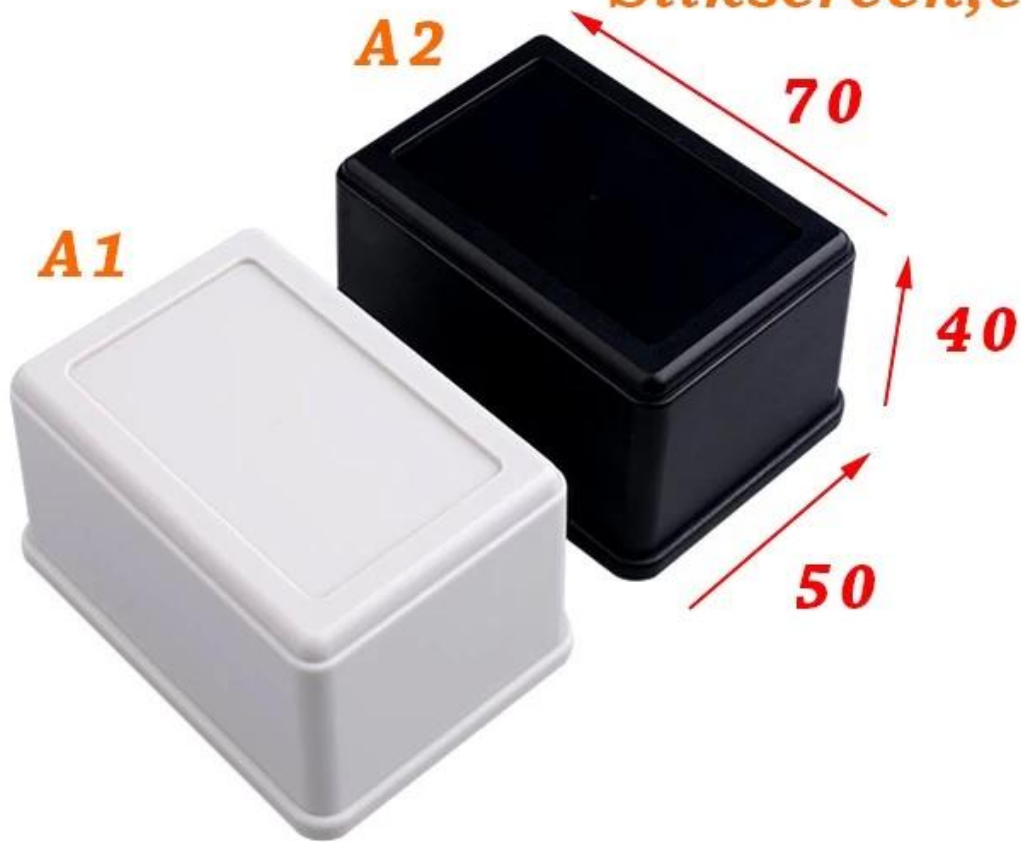

Weight :36 g

Model No. AK-S-11

70*50*40 mm

Size :2.76*1.97*1.57 inch

SZOMK



SZOMK



SZOMK



SZOMK



SZOMK

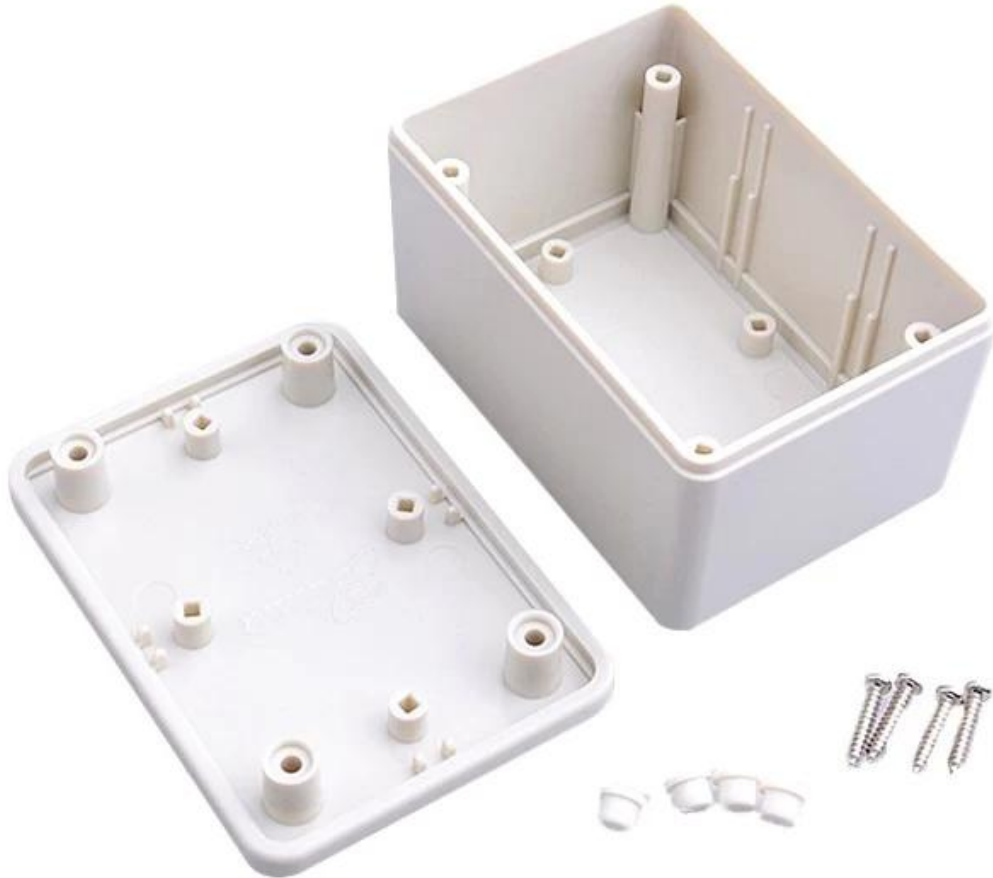

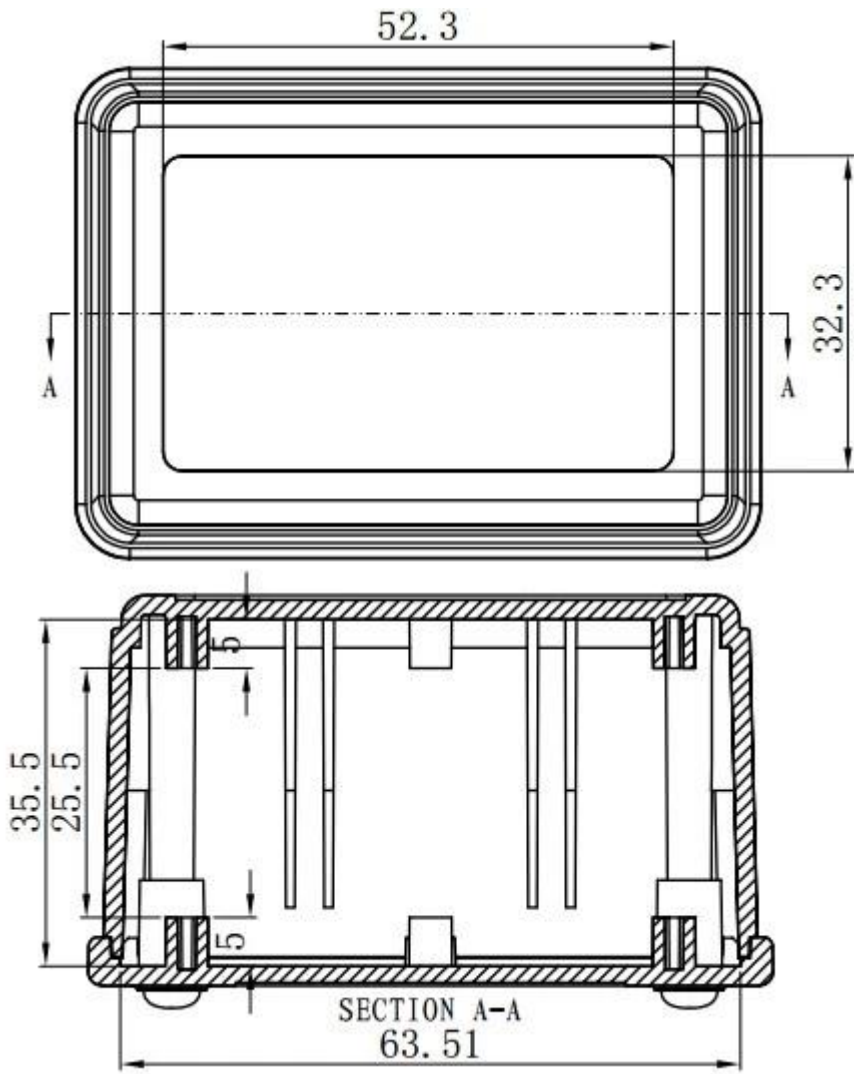

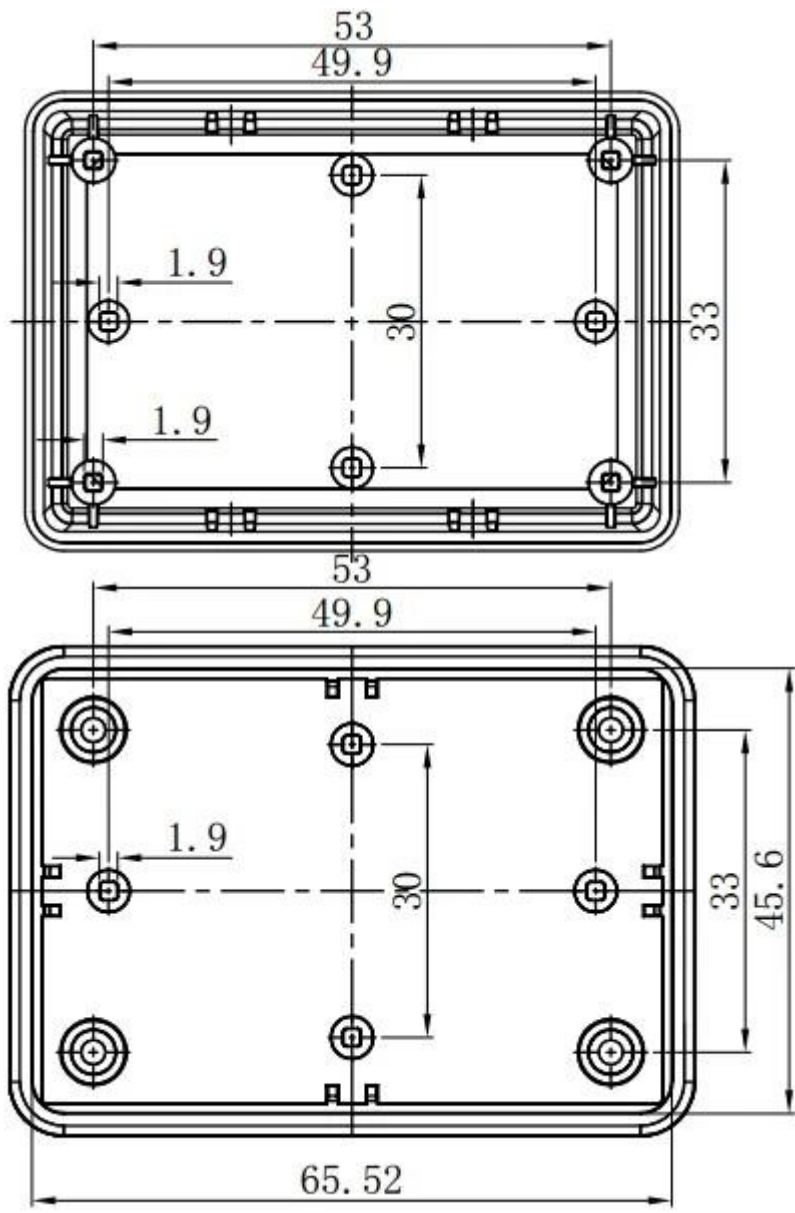

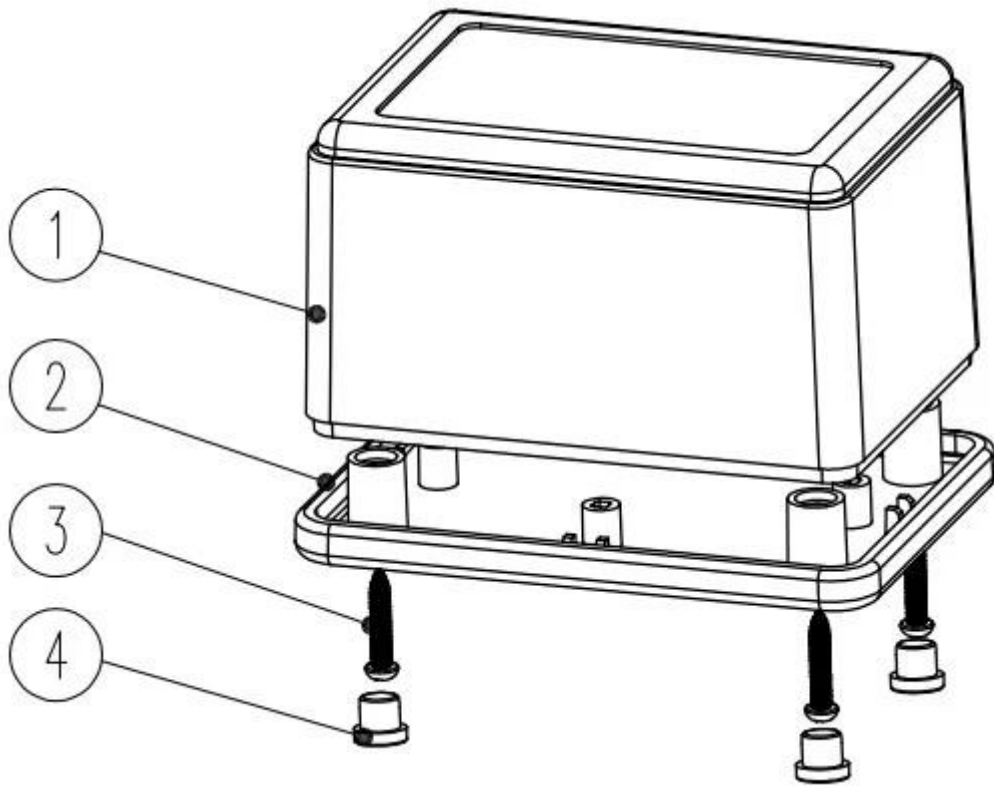



QQ

505924585



Tel

86-755-83222882
86-13028816914



Add

628Room,505 Building ,Shangbu industry,
Hangtian road ,Futian district ,Shenzhen,
China,518031



Email

lily@szomk.net



skype

szomk006