

## Product description:

1. Model number: AK-S-01
2. Size: 80x50x19mm
3. Color: A1, A2, A6, A8, A9, A11
4. Weight: 24g

**SZOMK**

*Customizable  
Cutout, sticker  
Silkscreen, color*



**Model No. AK-S-01**  
**Weight :24 g**

**Size: 3.15\*1.97\*0.75 inch**  
**80\*50\*19 mm**

**▶ Enclosure Manufacturer**  
**[www.chinaenclosure.com](http://www.chinaenclosure.com)**

**SZOMK**

*Customizable  
Cutout, sticker  
Silkscreen, color*



*Model No. AK-S-01  
Weight :24 g*

*Size: 3.15\*1.97\*0.75 inch  
80\*50\*19 mm*

▶ **Enclosure Manufacturer**  
[www.chinaenclosure.com](http://www.chinaenclosure.com)

**SZOMK**

*Customizable  
Cutout, sticker  
Silkscreen, color*



*Model No. AK-S-01  
Weight :24 g*

*Size: 3.15\*1.97\*0.75 inch  
80\*50\*19 mm*

**▶ Enclosure Manufacturer**  
[www.chinaenclosure.com](http://www.chinaenclosure.com)

**SZOMK**

**Customizable  
Cutout, sticker  
Silkscreen, color**



**Model No. AK-S-01**  
**Weight :24 g**

**Size: 3.15\*1.97\*0.75 inch**  
**80\*50\*19 mm**

**▶ Enclosure Manufacturer**  
**[www.chinaenclosure.com](http://www.chinaenclosure.com)**

**SZOMK**

**Customizable  
Cutout, sticker  
Silkscreen, color**



**Model No. AK-S-01**

**Weight :24 g**

**Size: 3.15\*1.97\*0.75 inch**

**80\*50\*19 mm**

**SZOMK**

**Customizable  
Cutout, sticker  
Silkscreen, color**



**Model No. AK-S-01**  
**Weight :24 g**

**Size: 3.15\*1.97\*0.75 inch**  
**80\*50\*19 mm**



**SZOMK**

A6



A2



A1



A8



A9



A11



**SZOMK**

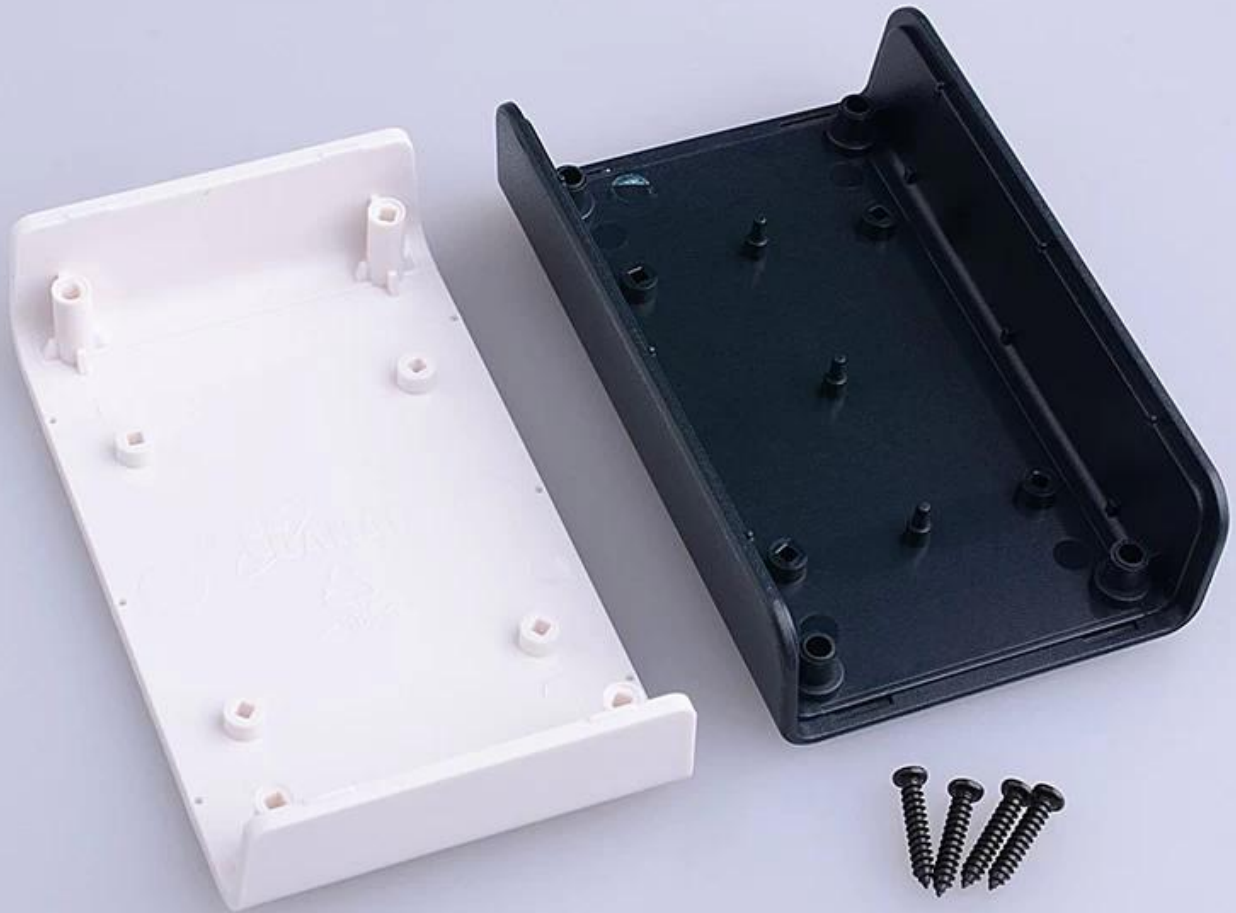

**SZOMK**



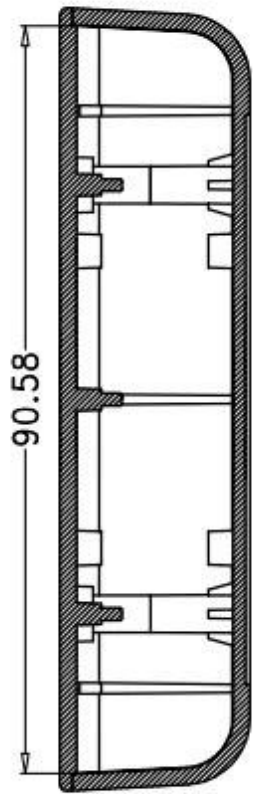

SECTION B-B

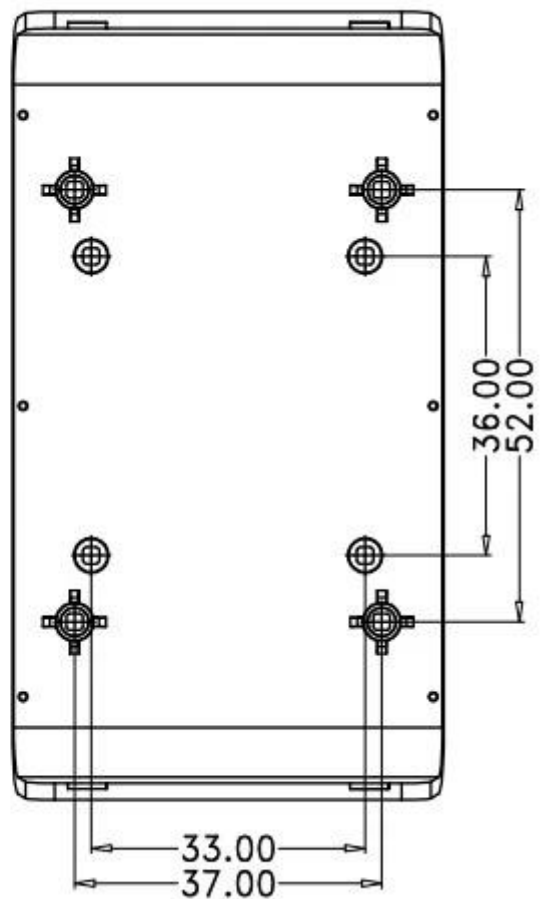
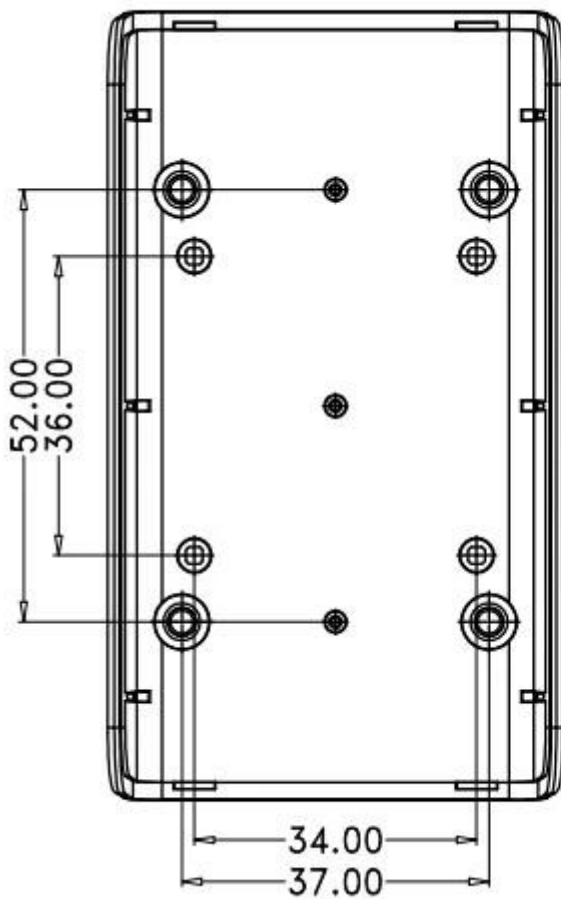
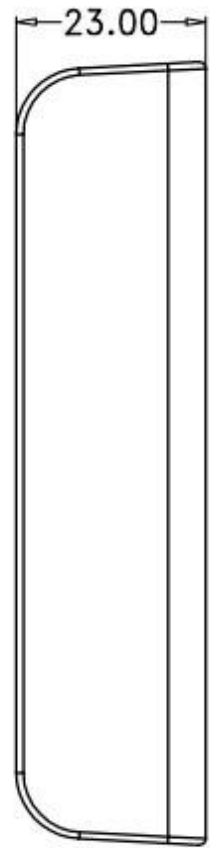
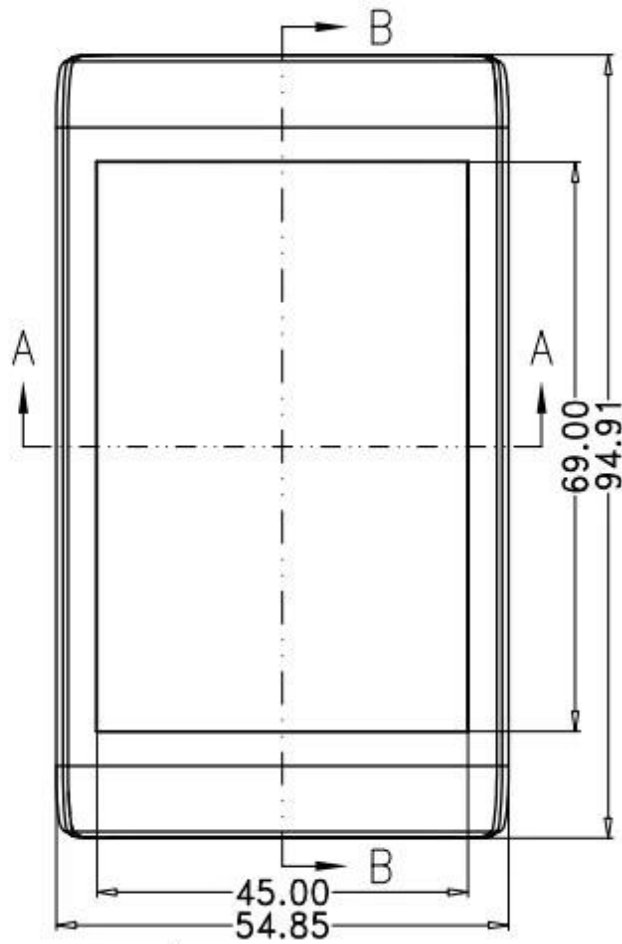

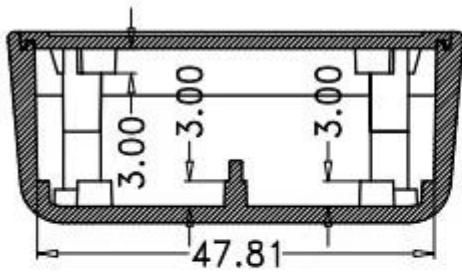

SECTION A-A

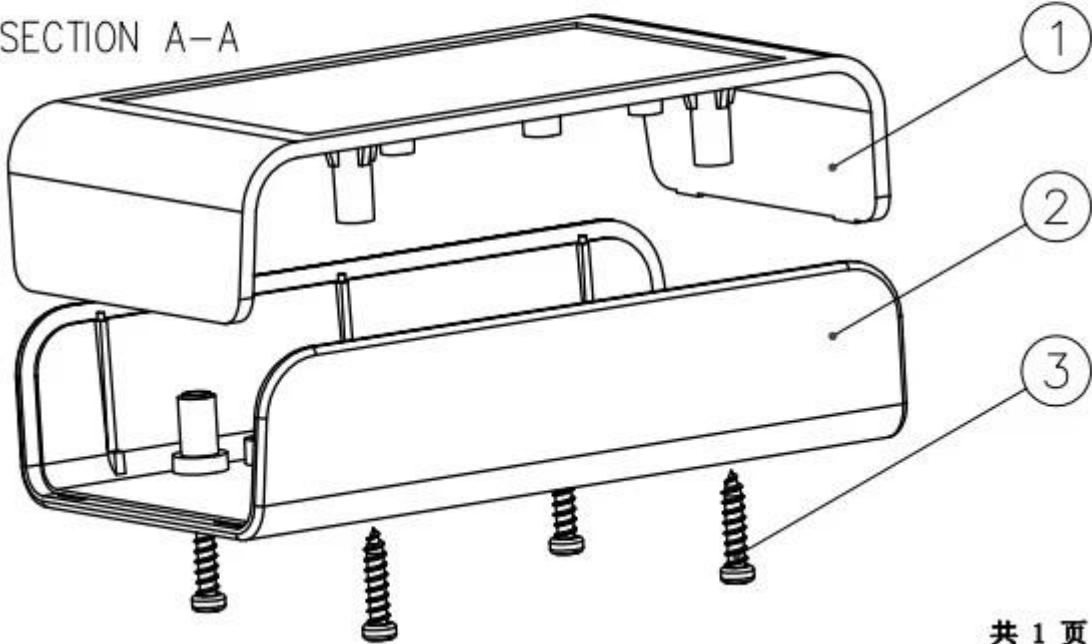

共 1 页

## Our customized service:

1. Change length
2. Change color
3. Polishing
4. Powder coating
5. Brushed aluminum foil
6. Drill holes
7. Laser engraving
8. PVC label
9. Acrylic plate
10. Silk screen

## Company Information



### Shenzhen Futian Huaqiang Electronic World OMK Electronic Sales Department

This complex, during long years of efforts with its own experienced group and sole facilities for improvement of productions and promotion of products quality, is now one of the largest suppliers of all kinds of metallic and plastic enclosures in different fields of electronic, electrical, communication, medical, industrial and research projects purposes.

In today's industrial world and with the rapid development of all industries, the need of these products is sensed more than ever. Therefore by offering the best quality and service, we try to meet these needs and help you to reach your ideals.

## Exhibition



## Certificate



## Factory and showroom



## Packaging & Shipping



# SZOMK

Shenzhen Futian Huaqiang Electronic World OMK Electronic Sales Department

Tel: +86-755-83222882 E-mail: ivy@szomk.com.cn



