

Especificações:

Local de origem: Shenzhen, China

Tipo: caixa de junção eletrônica platic do gabinete

Modelo no .: AK-S-77

Tamanho: 51 * 51 * 20mm

Material: plástico ABS

Exemplo de MOQ: 1 peça

**Personalizadoserviço: Entalhe, silkscreen, cor, etiqueta,
gravação do laser,
Acrílico folha, criar molde**

Personalizado MOQ: 20 pcs

Embalagem: caixa

SZOMK



▶ **Enclosure Manufacturer**
www.chinaenclosure.com

SZOMK

Customizable
cutout, sticker
silkscreen, color



Weight: 19g
Model No. AK-S-77

Size: 2.01*2.01*0.79 inch
51*51*20 mm

SZOMK



SZOMK



SZOMK



SZOMK



SZOMK



SZOMK



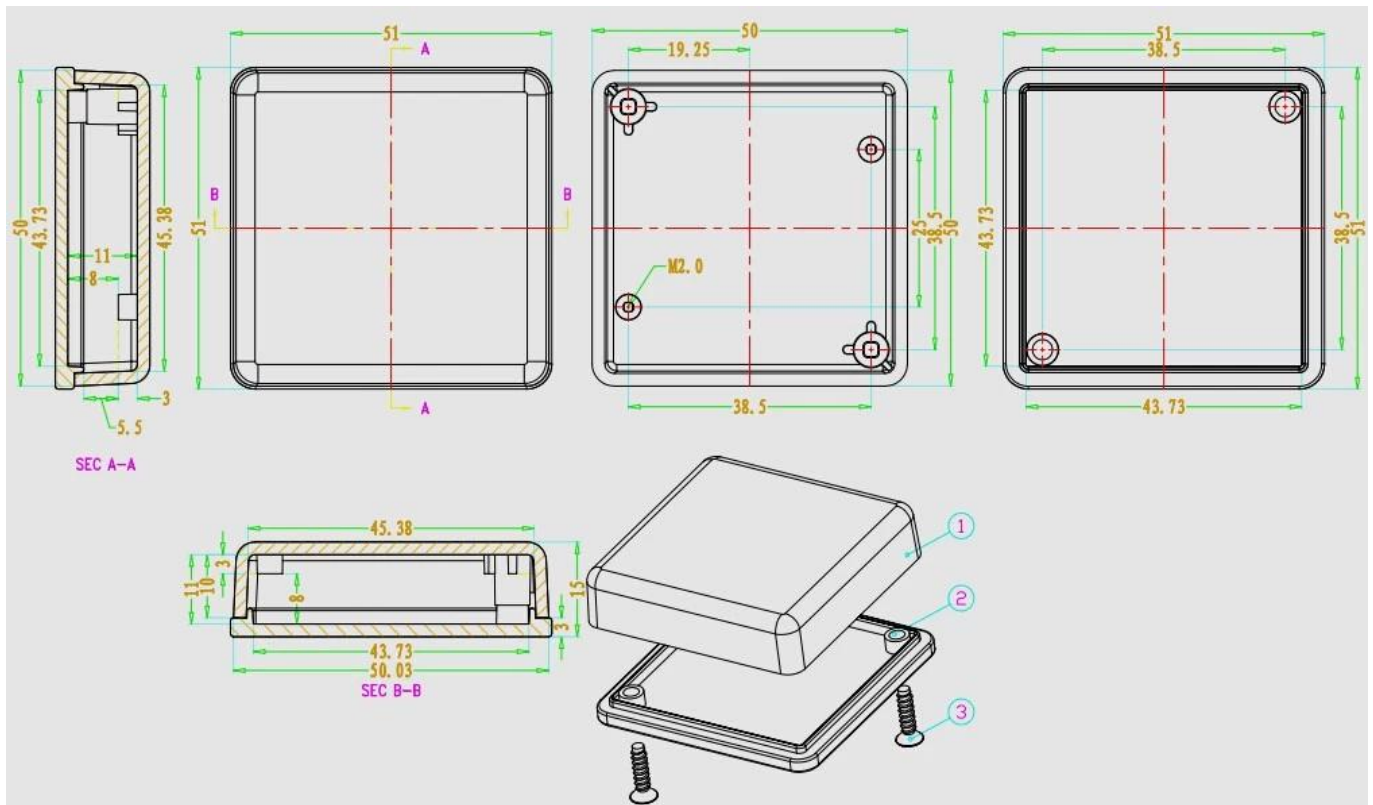

Está aqui nosso serviço da personalização:

- | | |
|-----------------------------------|--------------------------------|
| 1, mude o comprimento de alumínio | 2, mude a cor de nossas caixas |
| 3, produto de polimento | 4, revestimento em pó |
| 5, óleo escovado | 6, recorte |
| 7, gravação de lasers | 8, etiqueta de PVC |
| 9, placa acrílica | 10, serigrafia |
| 11, faça a etiqueta | 12, bordas de gel de sílica |
| 13, jateamento | 14, desenho de arame |
| 15, proteção UV | 16, molde aberto |



Plate



Silkscreen



Sticker

*We can do
customize*

Cutout



Silicone Seals



Color



We can do customize

Cut holes
Silkscreen
Sticker



We can do customize

change the color



We can do customize

PVC lable
Acrylic plate
Sticker



We can do customize

Cut holes
Silkscreen
Laser carve



We can do customize



**UV
Protection**



We can do customize

Cut holes
Silkscreen
Sticker



We can do customize



Usar:

É amplamente utilizado em eletrônica, instrumentação, automação, comunicação, fonte de alimentação une, projetos de estudante, amplificadores, equipamentos de saúde, equipamentos de teste e medição, controle industrial, dispositivos periféricos e interfaces, caixas de switch.

It is widely used in electronic, instrumentation, automation, communications, power supply units, student projects, amplifiers, Medical and wellness devices, test and measurement equipment, industrial control, peripheral devices and interfaces, switch boxes.



Atenção:

Boa vinda para contatar-nos para mais detalhes e cotações de nosso cerco, seu inquérito começará certamente a resposta imediata em 24 horas. -benzóico.



QQ

505924585



Tel

86-755-83222882
86-13028816914



Add

628Room,505 Building ,Shangbu industry,
Hangtian road ,Futian district ,Shenzhen,
China,518031



Email

lily@szomk.net



skype

szomk006

Company Information



Shenzhen Futian Huaqiang Electronic World OMK Electronic Sales Department

This complex, during long years of efforts with its own experienced group and sole facilities for improvement of productions and promotion of products quality, is now one of the largest suppliers of all kinds of metallic and plastic enclosures in different fields of electronic, electrical, communication, medical, industrial and research projects purposes.

In today's industrial world and with the rapid development of all industries, the need of these products is sensed more than ever. Therefore by offering the best quality and service, we try to meet these needs and help you to reach your ideals.

Exhibition



Certificate



Factory and showroom



Packaging & Shipping



Shenzhen Futian Huaqiang Electronic World OMK
Electronic Sales Department

Tel: +86-755-83222882 E-mail: hyj@szomk.com.cn



SZOMK

Our packaging

Plastic foam packaging



Metal shell packaging

Plastic box packaging



**Qualquer inquérito, entre em contato
com: lily@szomk.net**

**Seu inquérito seria responded withing 24
horas. O**

