

**SZOMK**



▶ **Enclosure Manufacturer**  
[www.chinaenclosure.com](http://www.chinaenclosure.com)

**SZOMK**



**SZOMK**



## Accessories

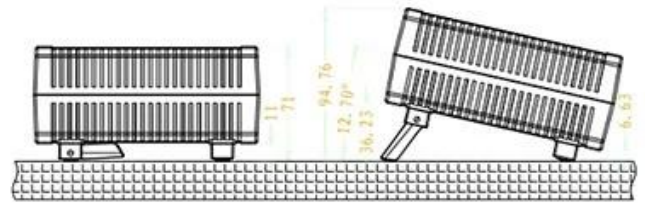
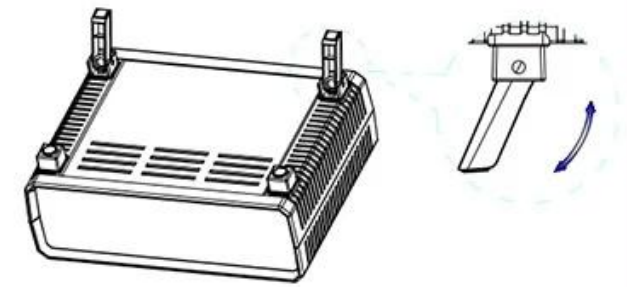
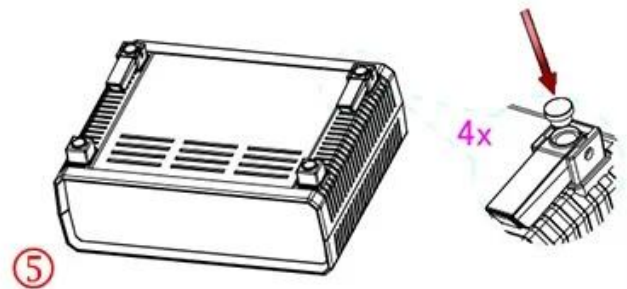
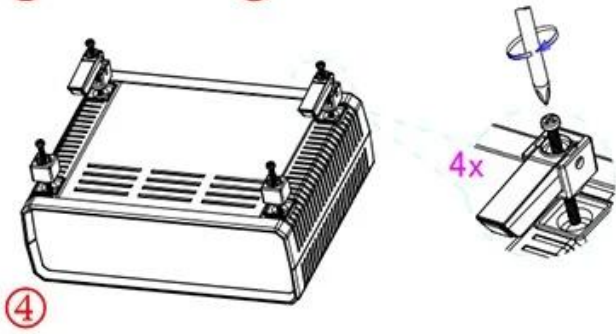
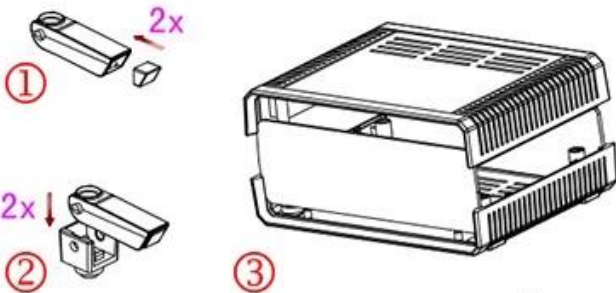
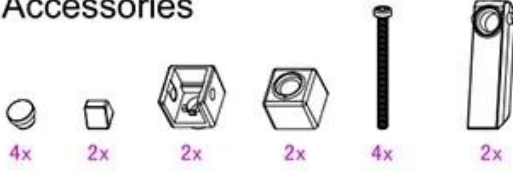

产品型号: AK-D-07

产品尺寸:180×140×60 mm

产品重量:



15221522

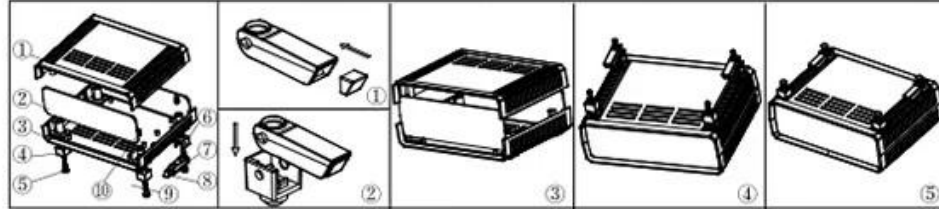

产品型号: 20012-B1  
产品名称: 上壳  
模具编号: BAH10061-A1A2  
材 料: ABS(电颜色:FS20412)  
用 量: 1 PCS



产品型号: 20012-D1  
产品名称: 挡板  
模具编号: BAH10061-A3  
材 料: ABS(电颜色:FS20412)  
用 量: 2 PCS



产品型号: 20012-C1  
产品名称: 下壳  
模具编号: BAH10061-A1A2  
材 料: ABS(电颜色:FS20412)  
用 量: 1 PCS



产品型号: 20009-E1  
产品名称: 后脚底座  
模具编号: BAH10058-A4A5  
材 料: ABS(电颜色:FS20412)  
用 量: 2 PCS



产品型号: BP-9  
产品名称: 脚垫  
模具编号: BAH10020-A4  
材 料: PVC(电颜色:FS20412)  
用 量: 4 PCS



产品型号: 20009-F1  
产品名称: 前脚底座  
模具编号: BAH10058-A4A5  
材 料: ABS(电颜色:FS20412)  
用 量: 2 PCS



产品型号: 20009-G1  
产品名称: 支撑架  
模具编号: BAH10058-A6  
材 料: ABS(电颜色:FS20412)  
用 量: 2 PCS



产品型号: 20009-H1  
产品名称: 脚垫  
模具编号: BAH10058-A7  
材 料: PVC(电颜色:FS20412)  
用 量: 2 PCS



产品型号: PM3x35  
产品名称: 螺丝  
规 格: M3×35  
材 料: 不锈钢  
用 量: 4 PCS



产品型号: M3×10  
产品名称: 铜套  
规 格: M3×10  
材 料: 铜  
用 量: 4 PCS  
颜 色: 铜色



QQ

2406659781



Tel

86-755-83222882  
86-18598241813



Add

628Room,505 Building ,Shangbu industry,  
Hangtian road ,Futian district ,Shenzhen,  
China,518031



Email

emily@szomk.com.cn



skype

szomk1010