

platic

AK-H-64

163×80×30mm

ABS

1

20

SZOMK



▶ **Enclosure Manufacturer**
www.chinaenclosure.com

SZOMK

Customizable
cutout, sticker
silkscreen, color



Weight: 107g
Model No. AK-H-64

Size: 6.42*3.15*1.18 inch
163*80*30 mm

SZOMK



SZOMK



SZOMK



SZOMK



SZOMK



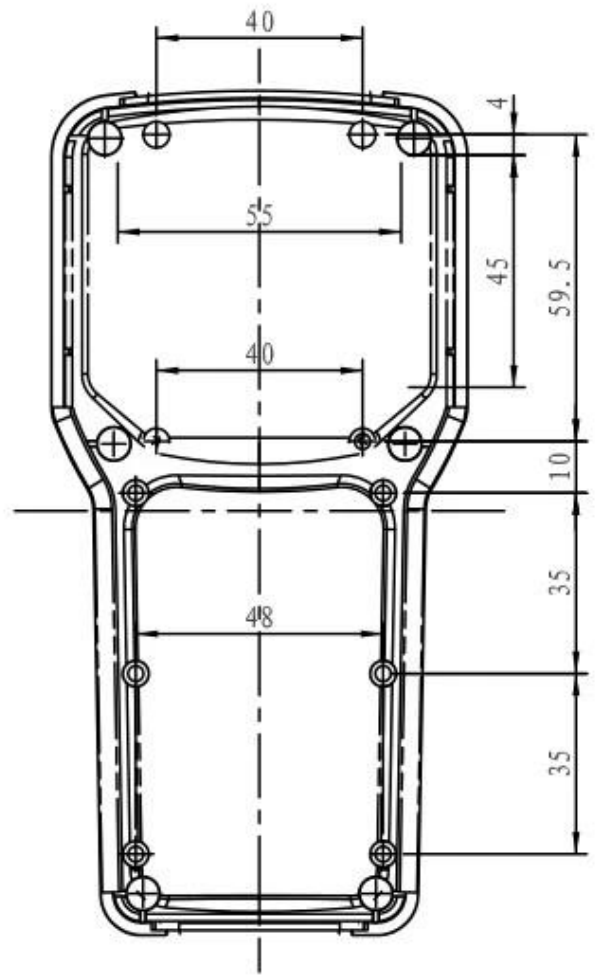
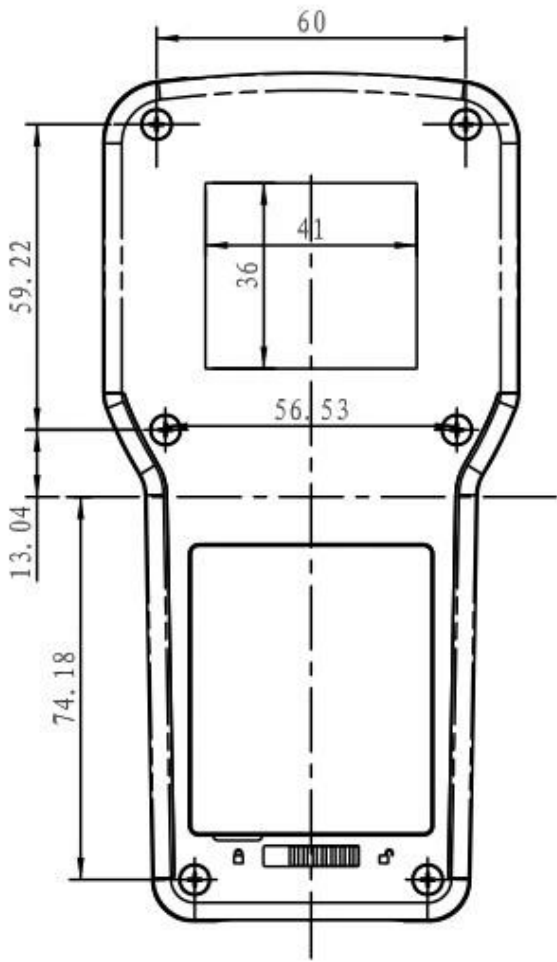

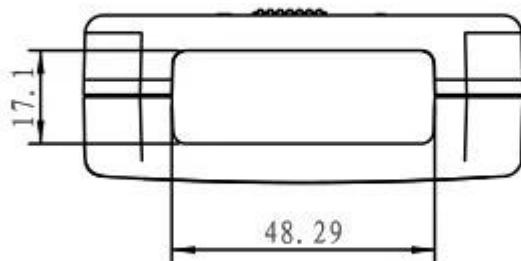
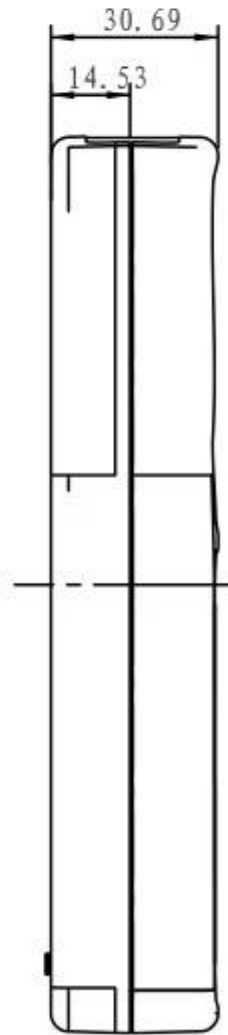
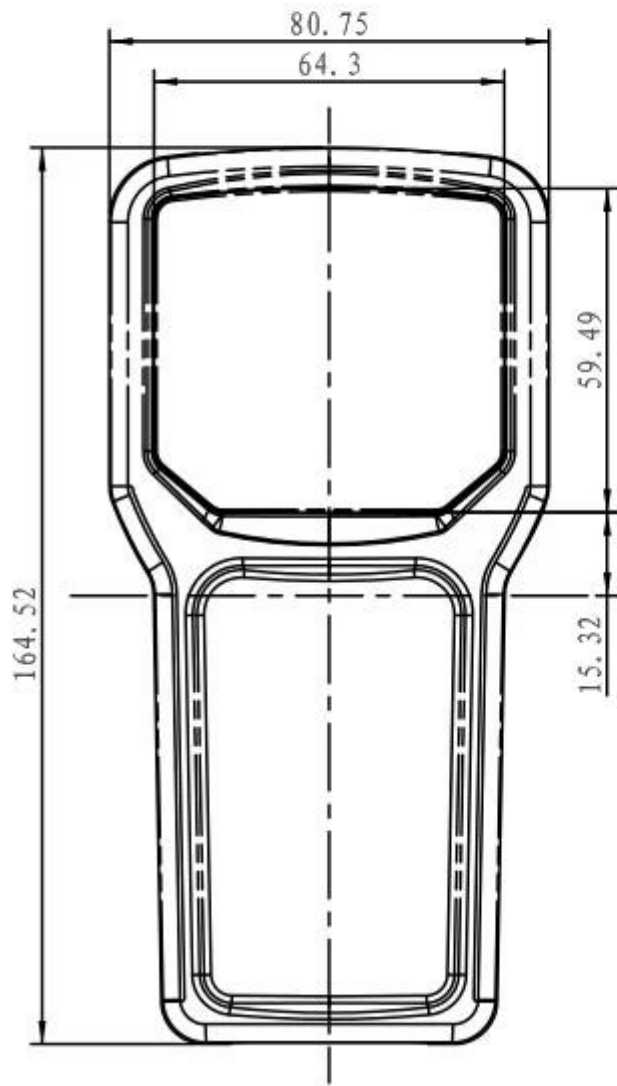
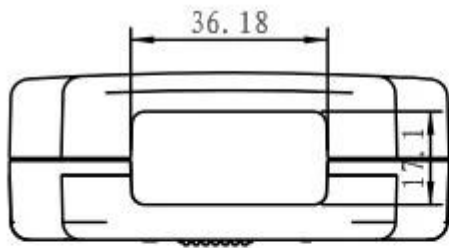

- 1 00000 2 00000000000
- 3 00000 4 00000
- 5 000 6 000
- 7 00000 8 PVC 00
- 9 00000 10 000
- 11 000 12 00000
- 13 000 14 000
- 15 00000 16 000

We can do customize

- Silkscreen**: A silver metal box with 'GPS Logistic' printed on it.
- Sticker**: A black rectangular sticker with 'CHIPTUNING-BOX' and 'CHIP TUNING MAX' printed on it.
- Silicone Seals**: A blue rectangular silicone frame.
- Color**: A collection of small, colorful rectangular pieces in blue, black, pink, yellow, and grey.
- Cutout**: A red metal box with two circular cutouts on its front panel.
- Plate**: A collection of various metal plates and components, including a yellow plate with holes, a black plate with holes, a blue plate, and a grey plate with 'R1000' printed on it.

We can do customize

Cut holes
Silkscreen
Sticker

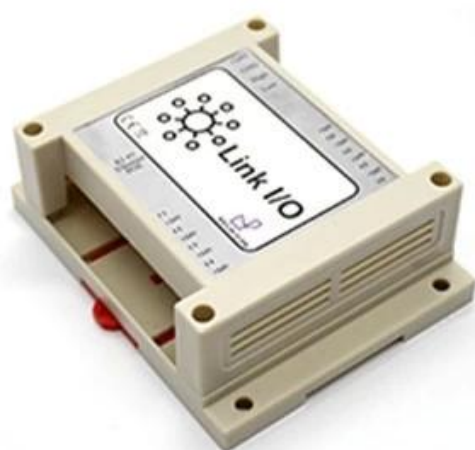

We can do customize

change the color



We can do customize

PVC lable
Acrylic plate
Sticker



We can do customize

Cut holes
Silkscreen
Laser carve



We can do customize



**UV
Protection**



We can do customize

Cut holes
Silkscreen
Sticker

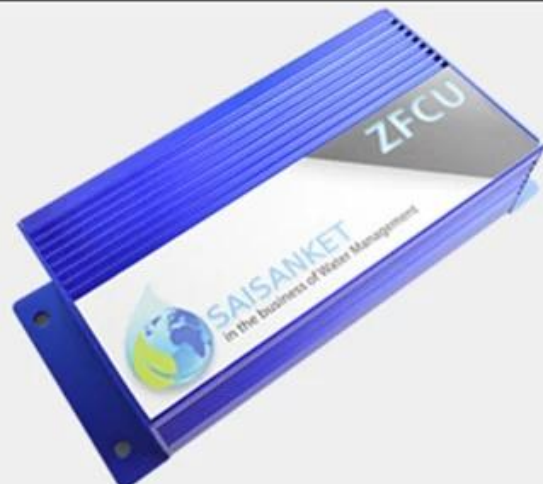

We can do customize



Polishing
Color

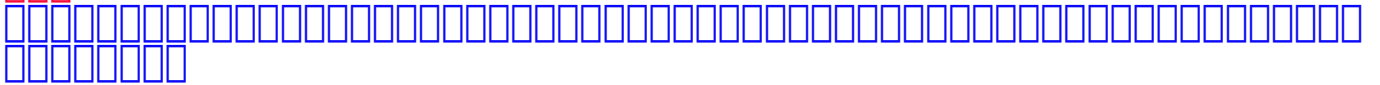



QQ

505924585



Tel

86-755-83222882
86-13028816914



Add

628Room,505 Building ,Shangbu industry,
Hangtian road ,Futian district ,Shenzhen,
China,518031



Email

lily@szomk.net



skype

szomk006

Company Information



Shenzhen Futian Huaqiang Electronic World OMK Electronic Sales Department

This complex, during long years of efforts with its own experienced group and sole facilities for improvement of productions and promotion of products quality, is now one of the largest suppliers of all kinds of metallic and plastic enclosures in different fields of electronic, electrical, communication, medical, industrial and research projects purposes.

In today's industrial world and with the rapid development of all industries, the need of these products is sensed more than ever. Therefore by offering the best quality and service, we try to meet these needs and help you to reach your ideals.

Exhibition



Certificate



Factory and showroom



Packaging & Shipping



Shenzhen Futian Huaqiang Electronic World OMK
Electronic Sales Department

Tel: +86-755-83222882 E-mail: hyj@szomk.com.cn



SZOMK

Our packaging

Plastic foam packaging



Metal shell packaging

Plastic box packaging



☐☐☐☐☐☐☐☐ lily@szomk.net

☐☐☐☐☐☐ **24**☐☐☐☐☐☐ ☐o☐