

Hier ist unser besonders anfertigen Service:

1. Ändern Sie die Länge
- Farbe 2. Ändern
3. Polieren
4. Sandstrahlen
5. gebürstetem Aluminiumfolie
6. Schneiden Sie Loch
7. Laser schnitzen
8. PVC-Aufkleber
9. Acrylplatte
10. Bildschirm

Verwenden Sie:

Es ist weit verbreitet in der Elektronik, Messtechnik, Automatisierung, Kommunikation, Stromversorgung vereint, Studentenprojekte, Verstärker, medizinische Geräte, Messtechnik, industrielle Steuerungen, Peripheriegeräte und Schnittstellen verwendet, Schaltkästen.

Achtung:

Willkommen bei uns für weitere Informationen und Angebote unserer Gehäuse zu kontaktieren, werden Ihre Anfrage sicherlich bekommen prompte Antwort in 24 Stunden. :-)

SZOMK

**Customizable
Cutout, sticker
Silkscreen, color**

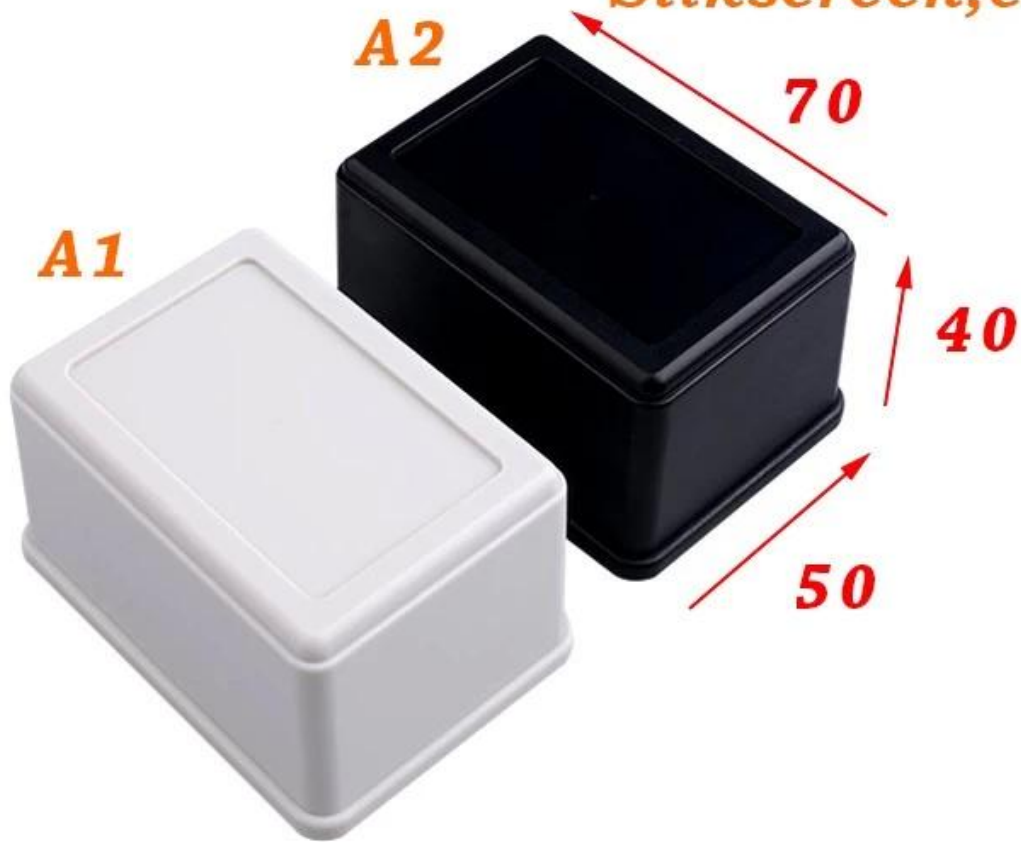

Weight :36 g

Model No. AK-S-11

70*50*40 mm

Size :2.76*1.97*1.57 inch

SZOMK



SZOMK



SZOMK



SZOMK



SZOMK

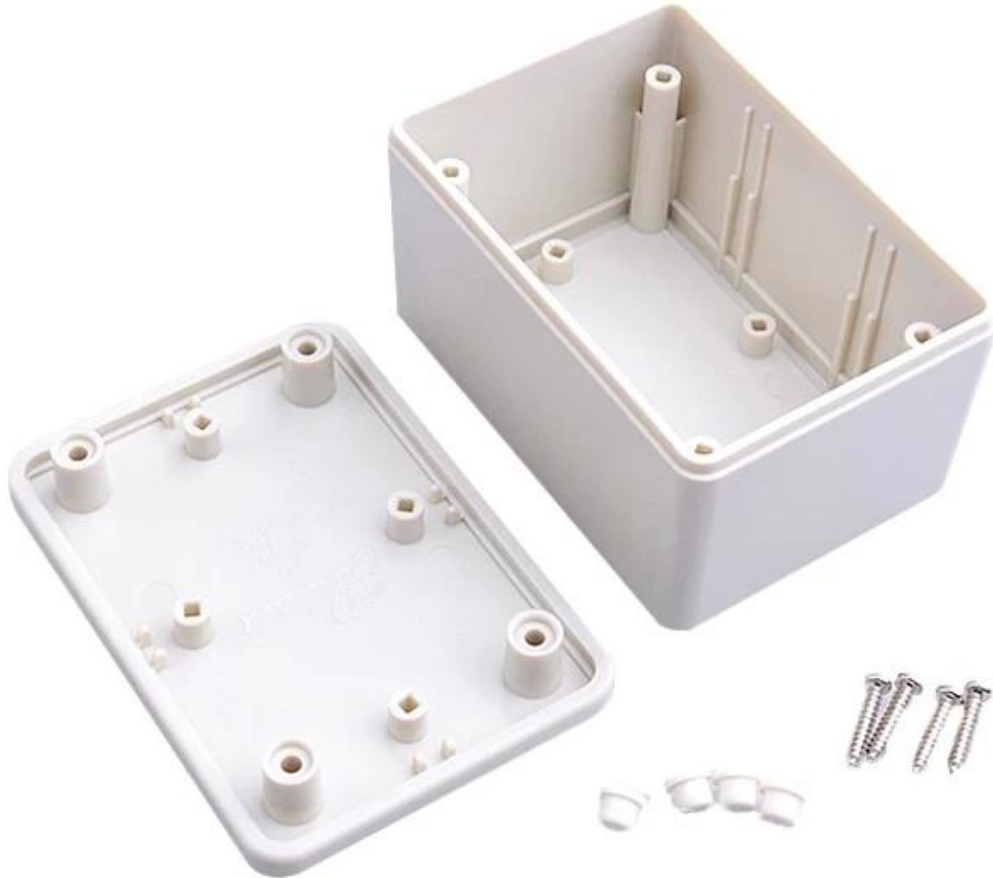

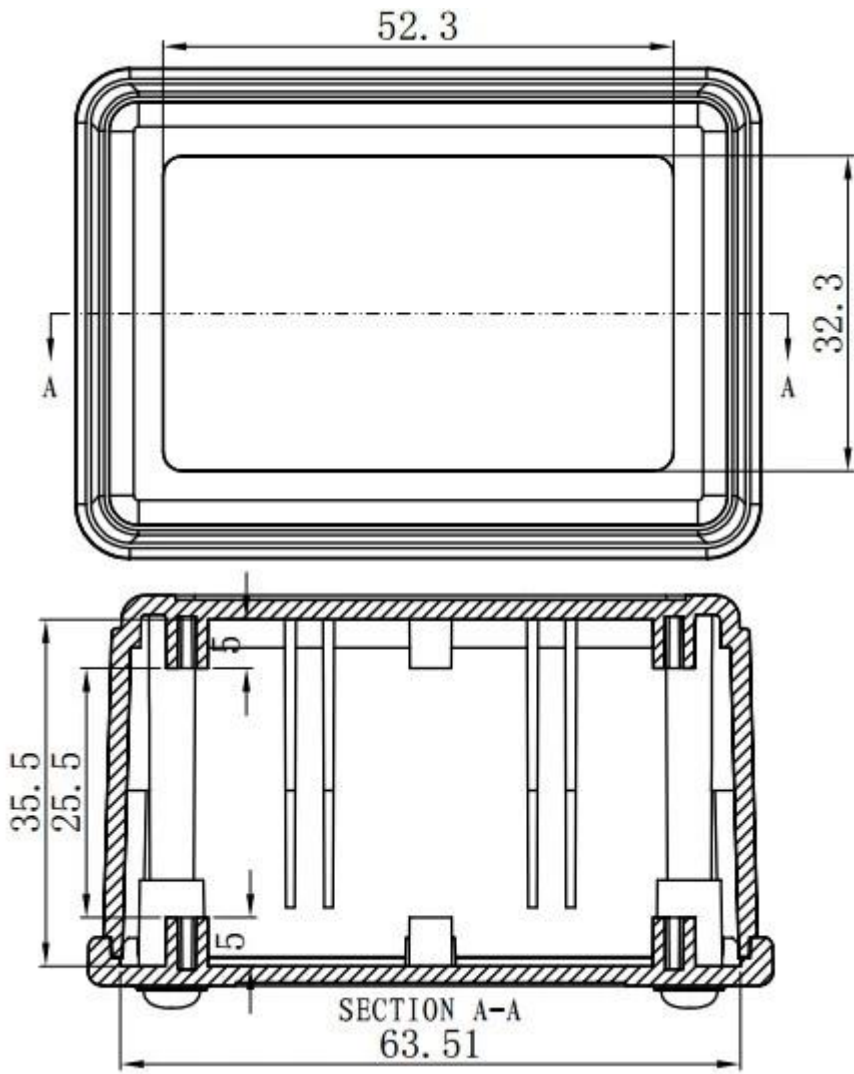

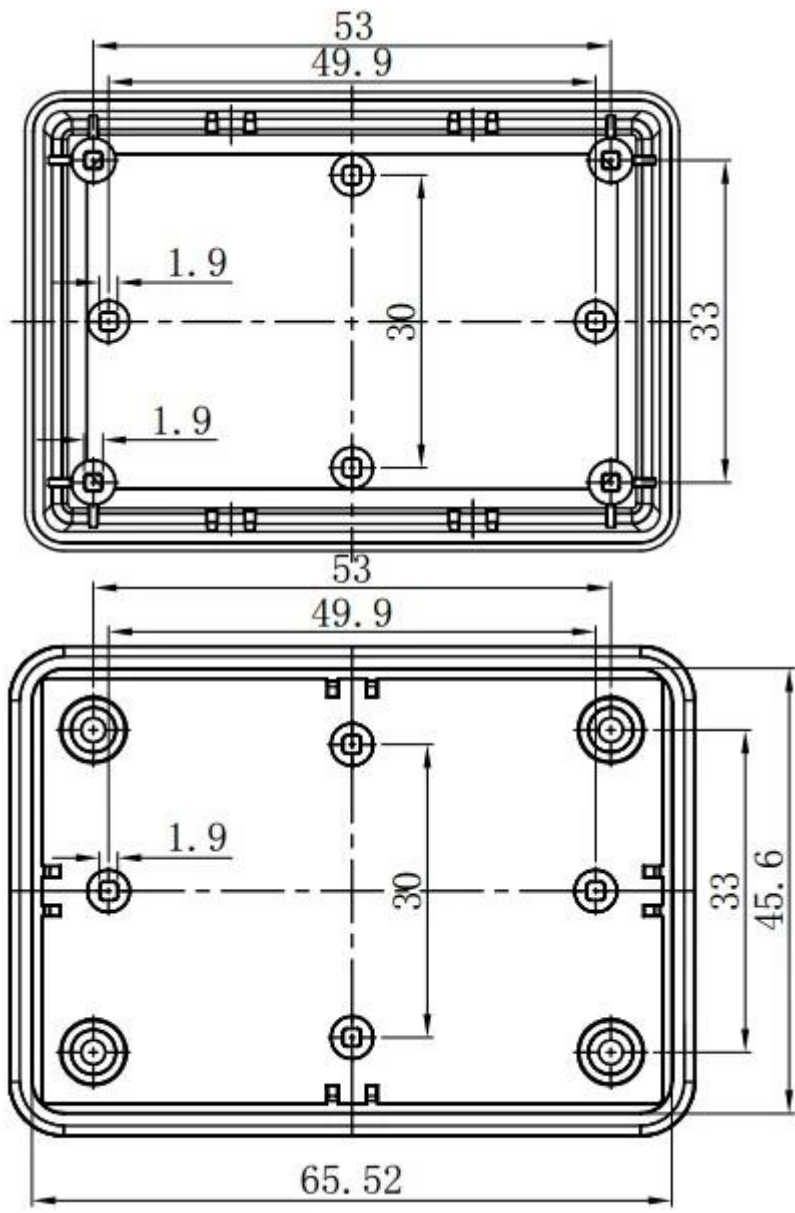

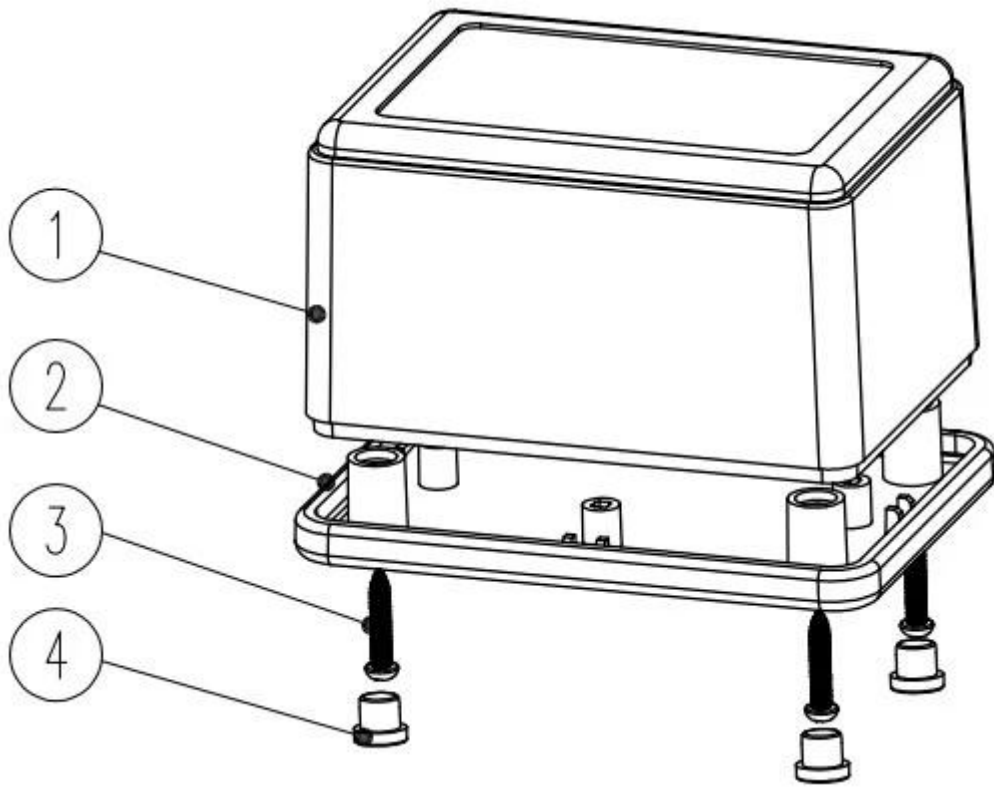



QQ

505924585



Tel

86-755-83222882
86-13028816914



Add

628Room,505 Building ,Shangbu industry,
Hangtian road ,Futian district ,Shenzhen,
China,518031



Email

lily@szomk.net



skype

szomk006