

## Hier ist unser besonders anfertigen Service:

1. Ändern Sie die Länge
- Farbe 2. Ändern
3. Polieren
4. Sandstrahlen
5. gebürstetem Aluminiumfolie
6. Schneiden Sie Loch
7. Laser schnitzen
8. PVC-Aufkleber
9. Acrylplatte
10. Bildschirm

## Verwenden Sie:

Es ist weit verbreitet in der Elektronik, Messtechnik, Automatisierung, Kommunikation, Stromversorgung vereint, Studentenprojekte, Verstärker, medizinische Geräte, Messtechnik, industrielle Steuerungen, Peripheriegeräte und Schnittstellen verwendet, Schaltkästen.

## Achtung:

Willkommen bei uns für weitere Informationen und Angebote unserer Gehäuse zu kontaktieren, werden Ihre Anfrage sicherlich bekommen prompte Antwort in 24 Stunden: .-)

**SZOMK**

Customizable  
Cutout, sticker  
Silkscreen, color



Weight :189 g  
Model No. AK-H-36

Size:6.73\*3.86\*1.22 inch  
171\*98\*31 mm

**SZOMK**

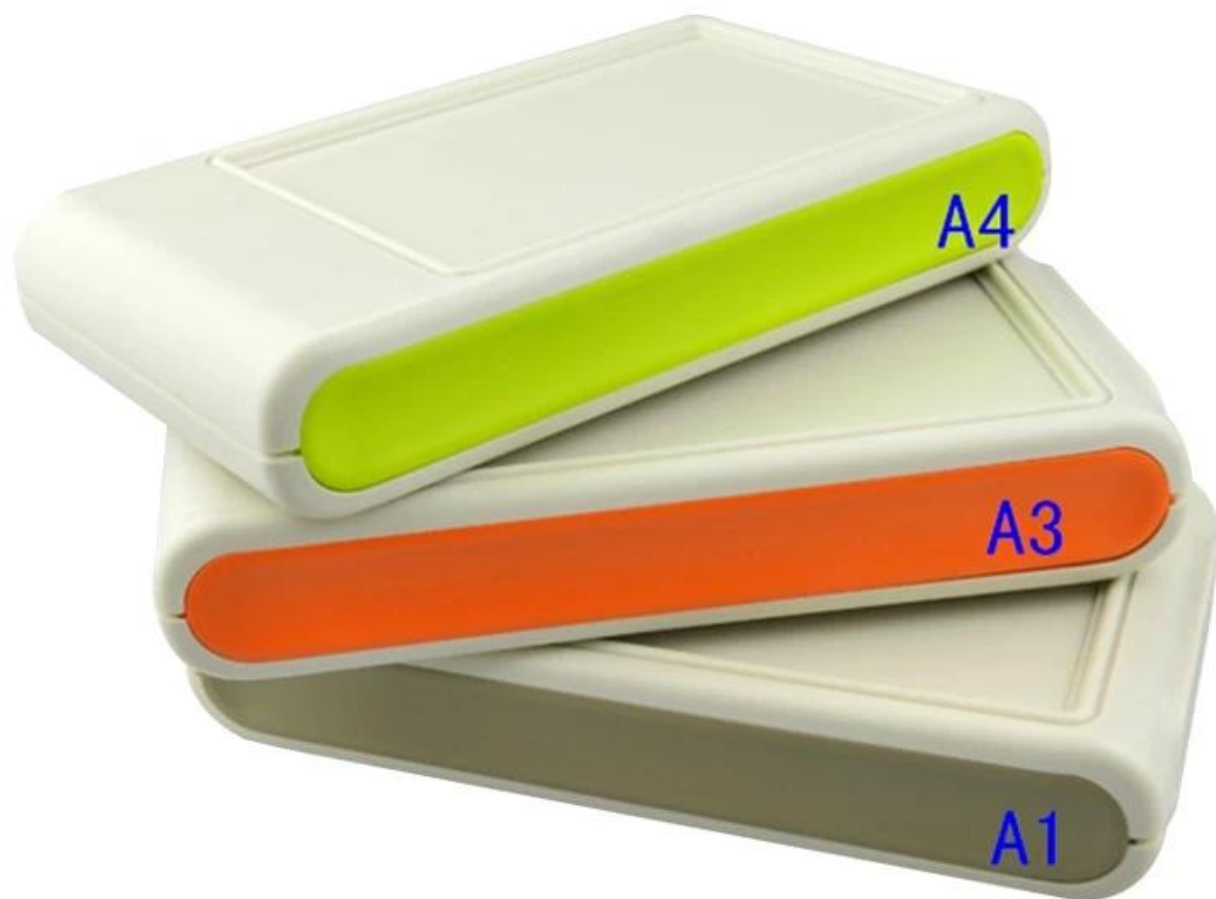

**SZOMK**

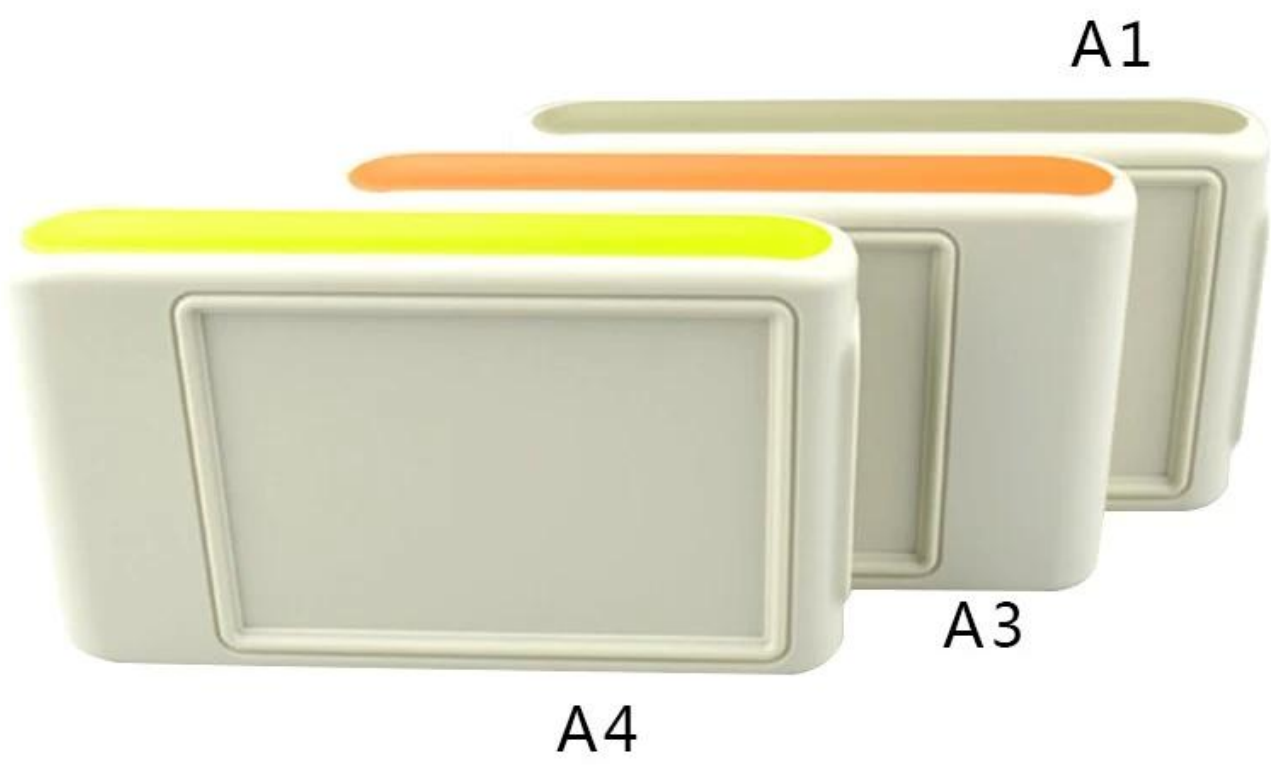

**SZOMK**



**SZOMK**



**SZOMK**

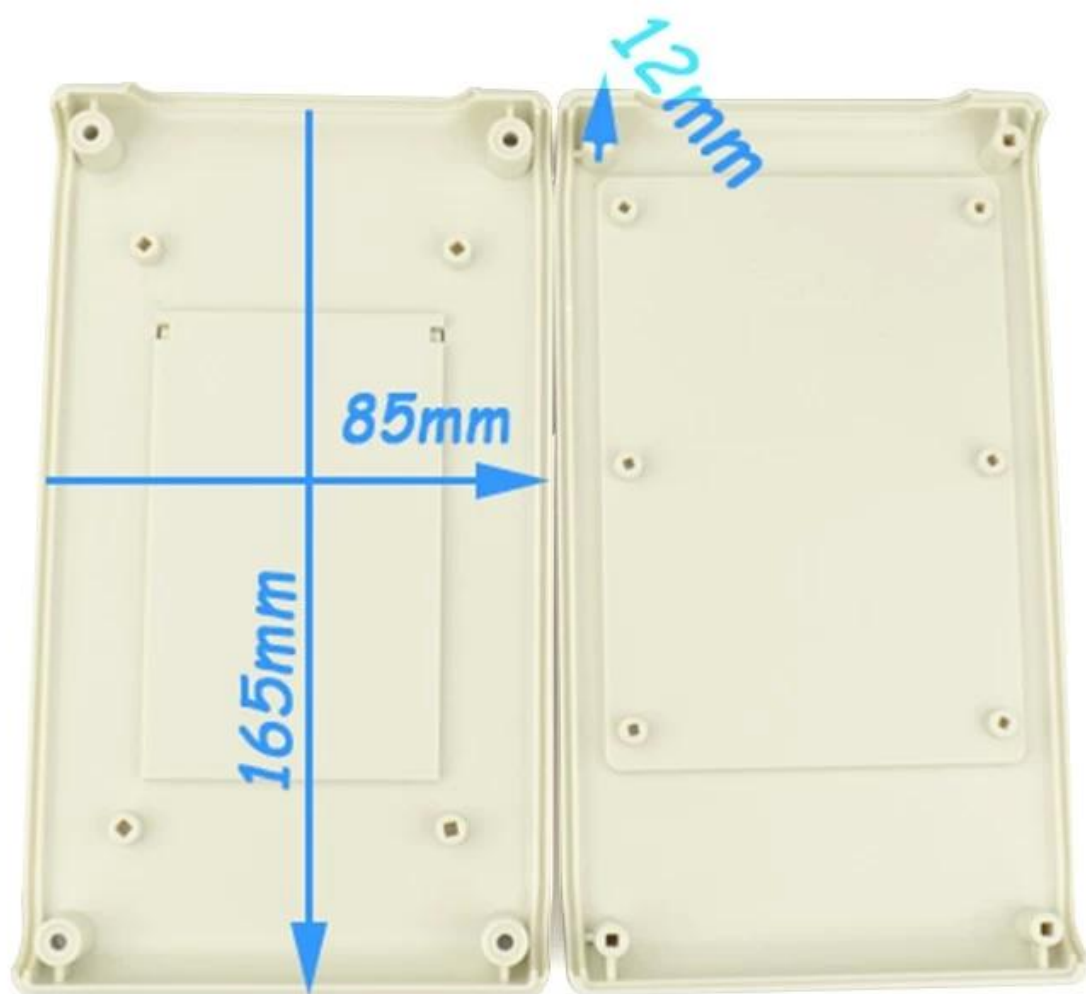

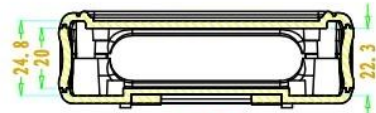
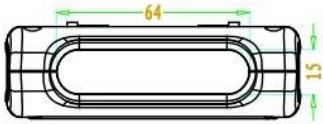

SEC B-B

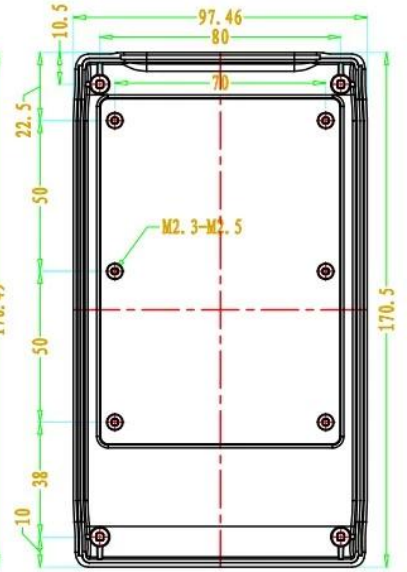
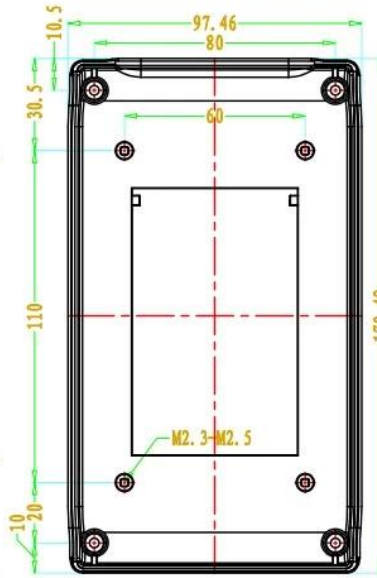
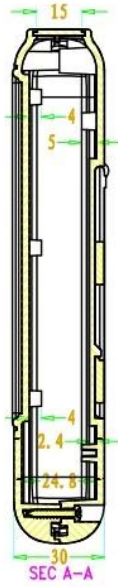
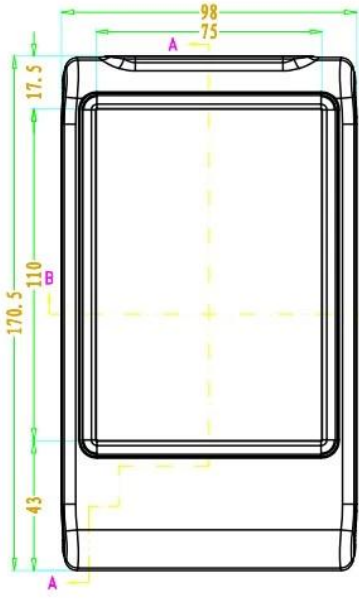



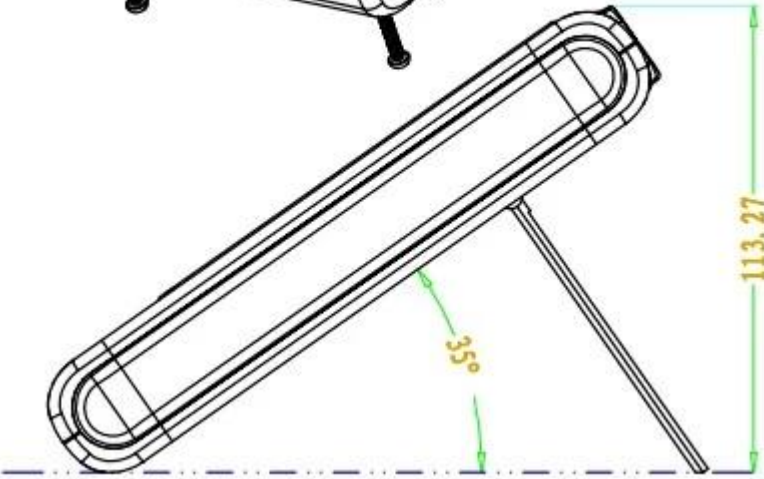

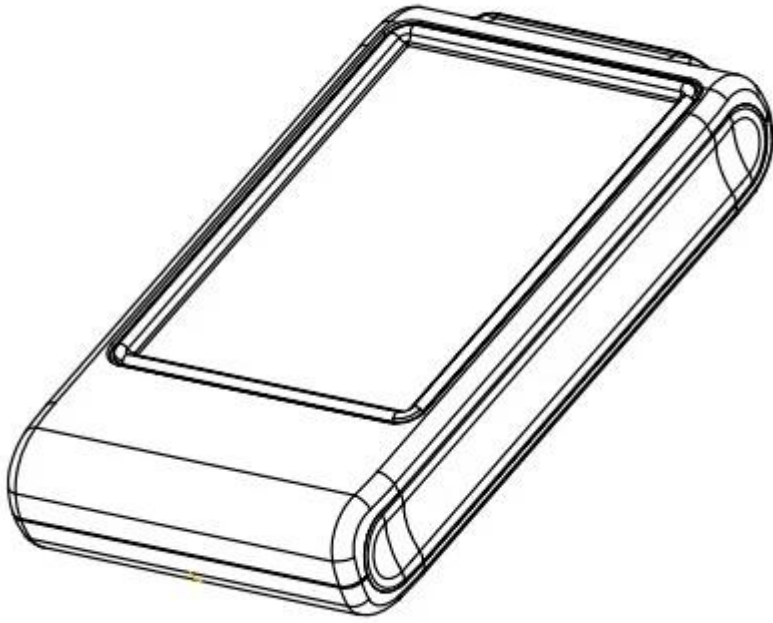



QQ

505924585



Tel

86-755-83222882  
86-13028816914



Add

628Room,505 Building ,Shangbu industry,  
Hangtian road ,Futian district ,Shenzhen,  
China,518031



Email

[lily@szomk.net](mailto:lily@szomk.net)



skype

szomk006