

SZOMK



▶ **Enclosure Manufacturer**
www.chinaenclosure.com

SZOMK



SZOMK



Accessories

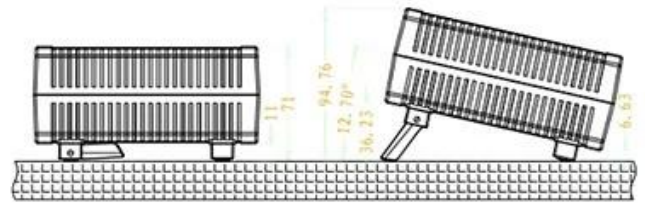
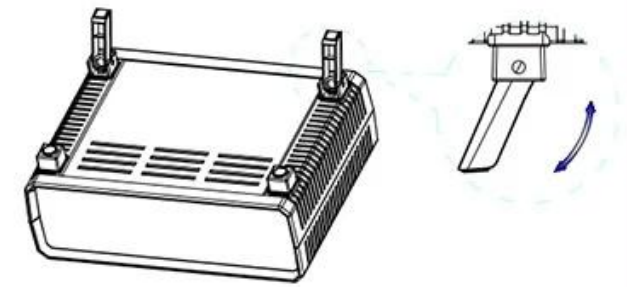
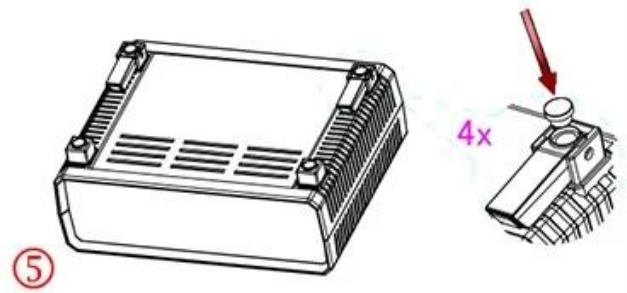
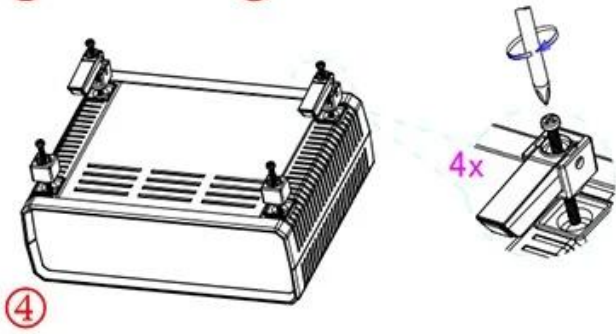
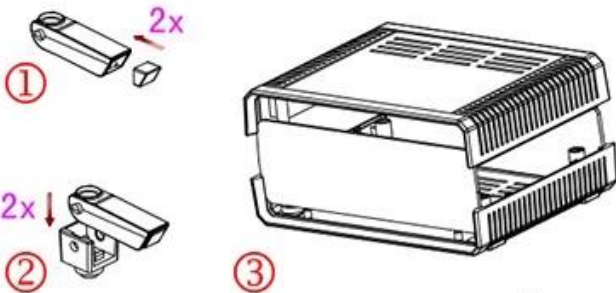
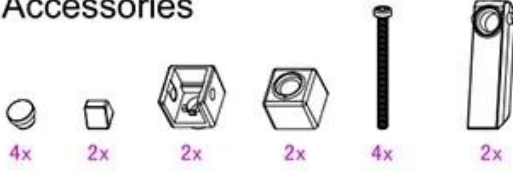

产品型号: AK-D-07

产品尺寸:180×140×60 mm

产品重量:



15221522

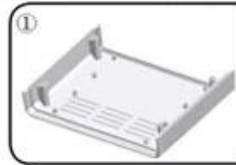
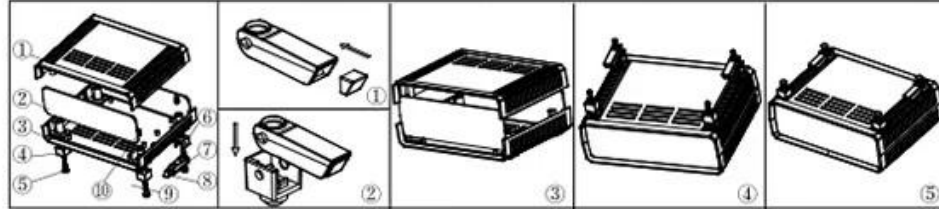

产品型号: 20012-B1
产品名称: 上壳
模具编号: BAH10061-A1A2
材 料: ABS(电脑色:FS20412)
用 量: 1 PCS



产品型号: 20012-D1
产品名称: 挡板
模具编号: BAH10061-A3
材 料: ABS(电脑色:FS20412)
用 量: 2 PCS



产品型号: 20012-C1
产品名称: 下壳
模具编号: BAH10061-A1A2
材 料: ABS(电脑色:FS20412)
用 量: 1 PCS



产品型号: 20009-E1
产品名称: 后脚底座
模具编号: BAH10058-A4A5
材 料: ABS(电脑色:FS20412)
用 量: 2 PCS



产品型号: BP-9
产品名称: 脚垫
模具编号: BAH10020-A4
材 料: PVC(电脑色:FS20412)
用 量: 4 PCS



产品型号: 20009-F1
产品名称: 前脚底座
模具编号: BAH10058-A4A5
材 料: ABS(电脑色:FS20412)
用 量: 2 PCS



产品型号: 20009-G1
产品名称: 支撑架
模具编号: BAH10058-A6
材 料: ABS(电脑色:FS20412)
用 量: 2 PCS



产品型号: 20009-H1
产品名称: 脚垫
模具编号: BAH10058-A7
材 料: PVC(电脑色:FS20412)
用 量: 2 PCS



产品型号: PM3x35
产品名称: 螺丝
规 格: M3×35
材 料: 不锈钢
用 量: 4 PCS



产品型号: M3×10
产品名称: 铜套
规 格: M3×10
材 料: 铜
用 量: 4 PCS
颜 色: 铜色



QQ

2406659781



Tel

86-755-83222882
86-18598241813



Add

628Room,505 Building ,Shangbu industry,
Hangtian road ,Futian district ,Shenzhen,
China,518031



Email

emily@szomk.com.cn



skype

szomk1010