

Aquí está nuestro servicio para requisitos particulares:

1. Cambiar la longitud
2. Cambiar el color
3. Pulido
4. chorro de arena
5. Cepillado papel de aluminio
6. Corte
7. Laser
8. etiqueta PVC
9. acrílico placa
10. Pantalla

Uso:

Es ampliamente utilizado en la electrónica, instrumentación, automatización, comunicación, una fuente de alimentación, proyectos estudiantiles, amplificadores, equipos médicos, equipos de prueba y medición, control industrial, dispositivos e interfaces de periféricos, cajas de interruptores.

Atención:

Bienvenido a ponerse en contacto con nosotros para más detalles y citas de nuestro recinto, su pregunta será seguramente obtener pronta respuesta en 24 horas: .-)

SZOMK

Customizable
Cutout, sticker
Silkscreen, color



Weight :189 g
Model No. AK-H-36

Size:6.73*3.86*1.22 inch
171*98*31 mm

SZOMK

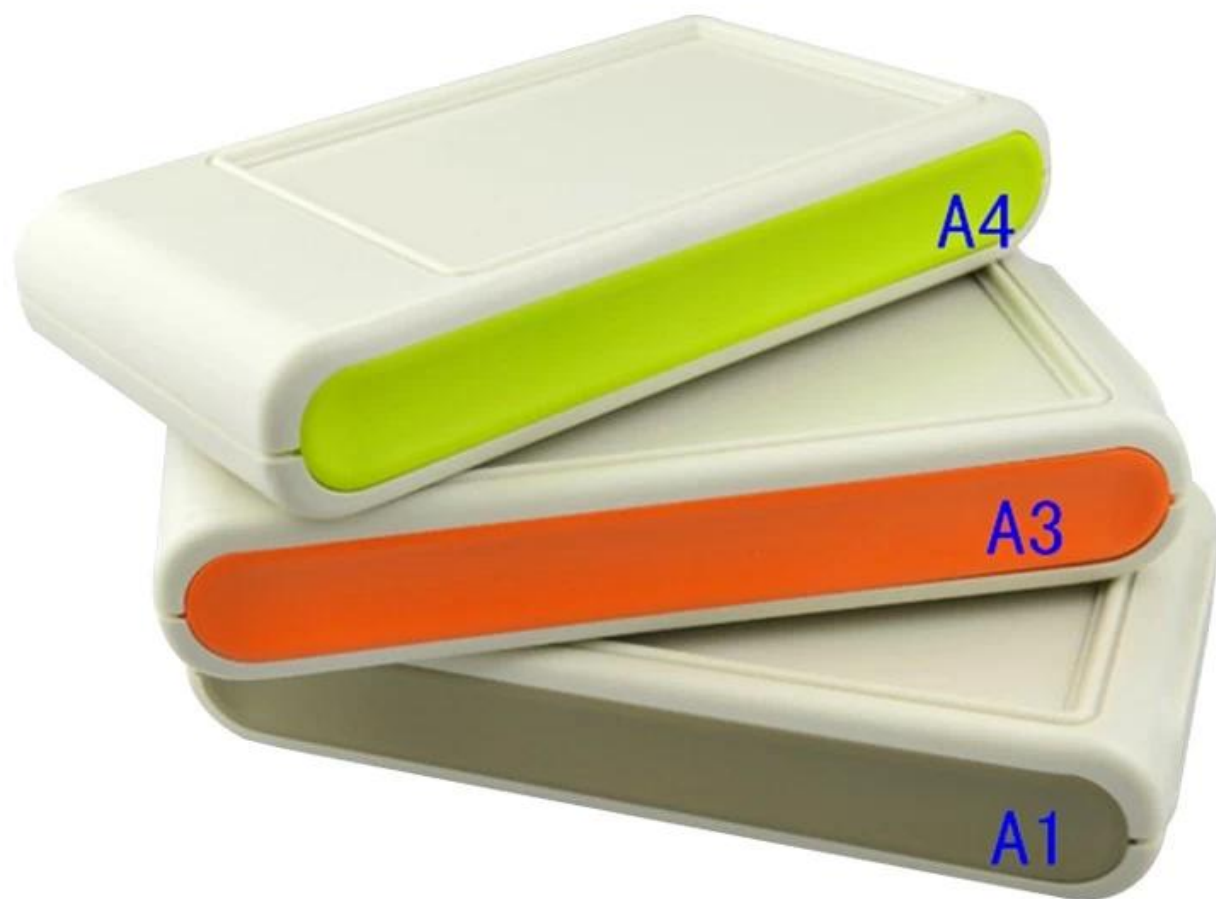

SZOMK

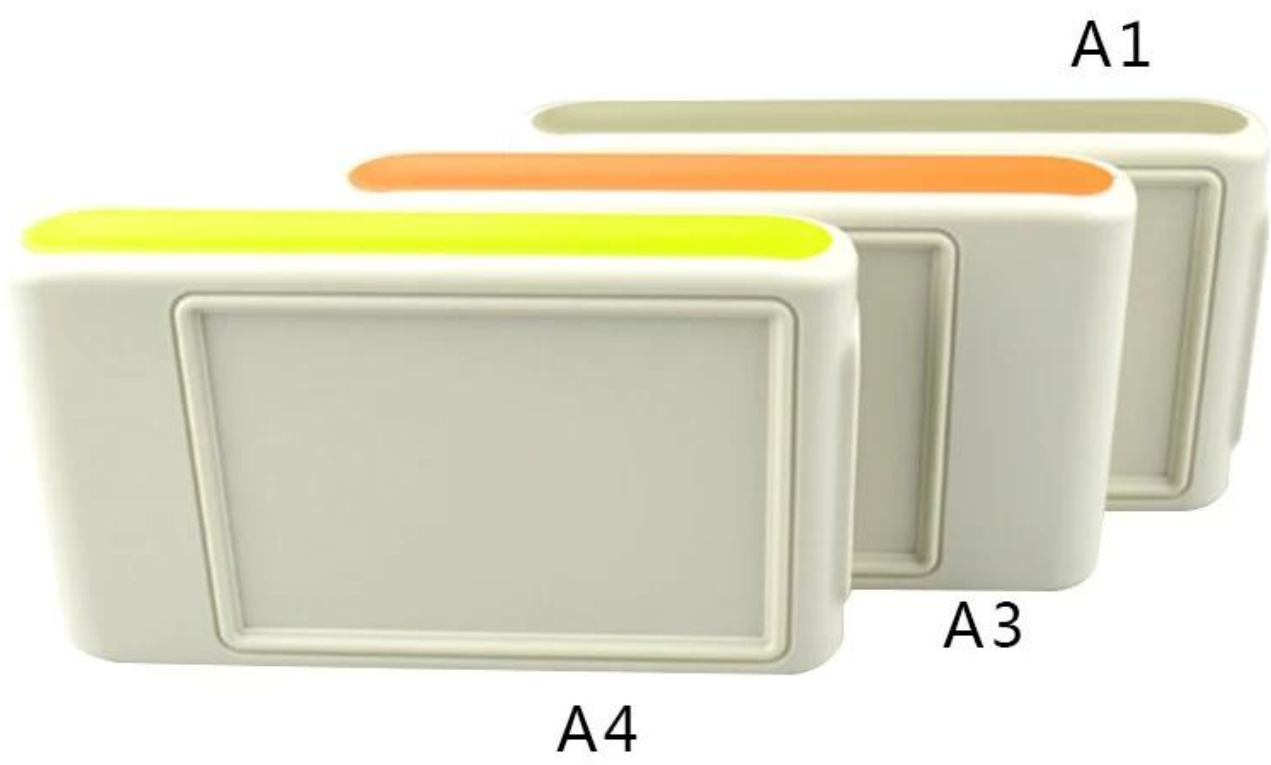

SZOMK



SZOMK



SZOMK

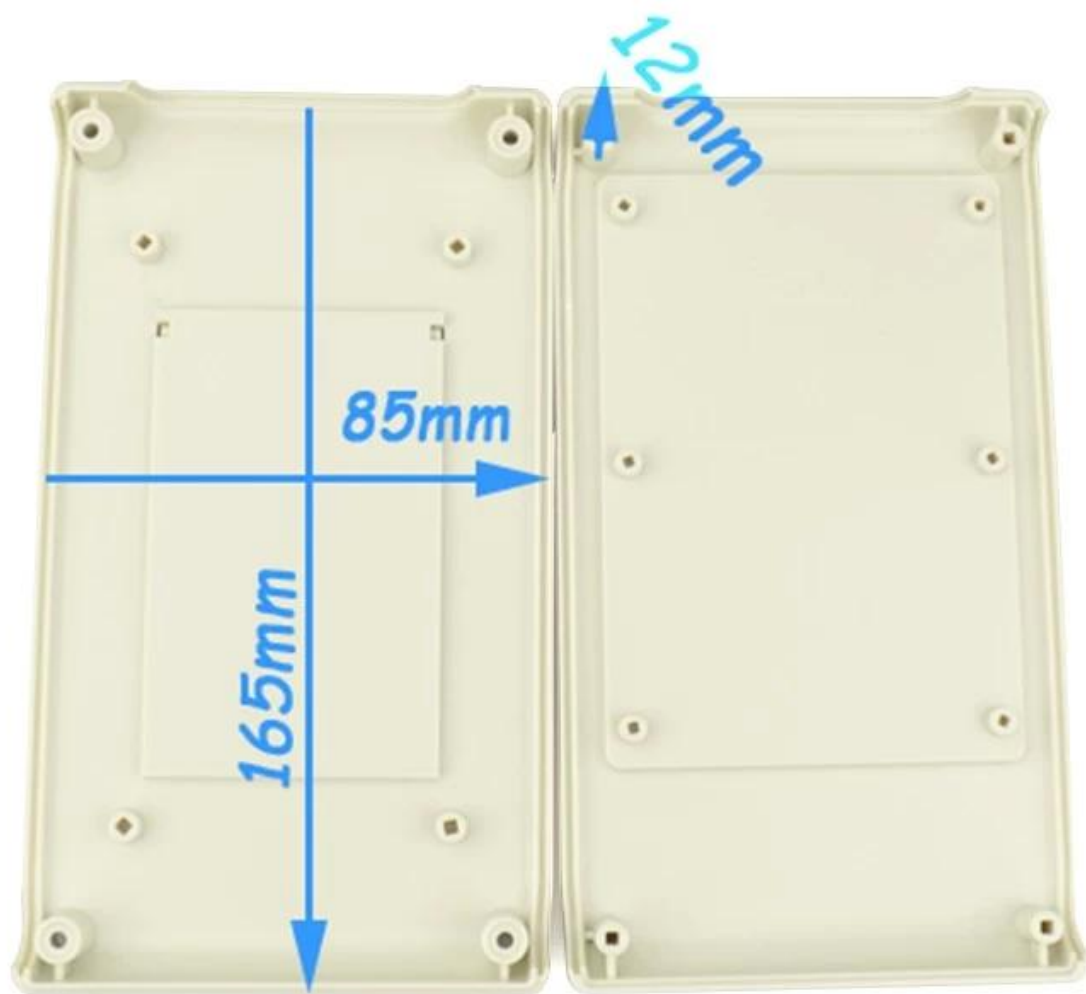

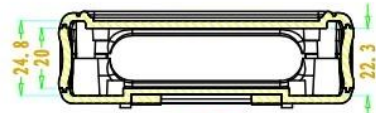
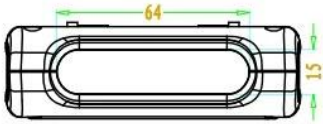

SEC B-B

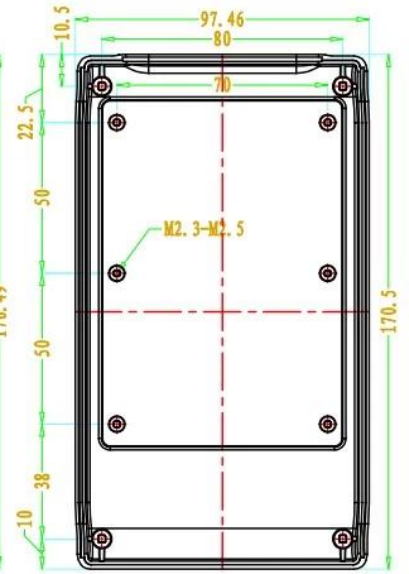
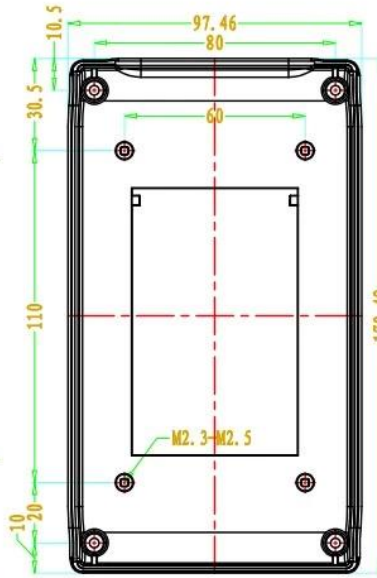
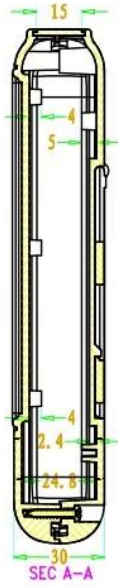
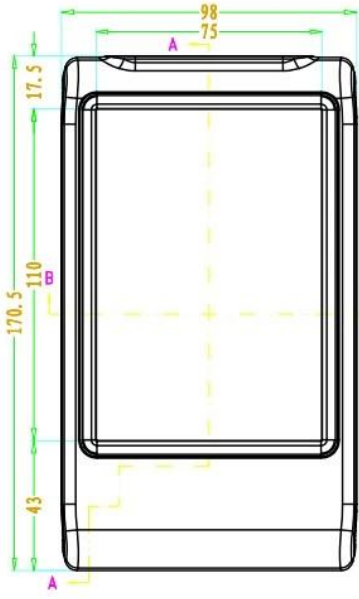

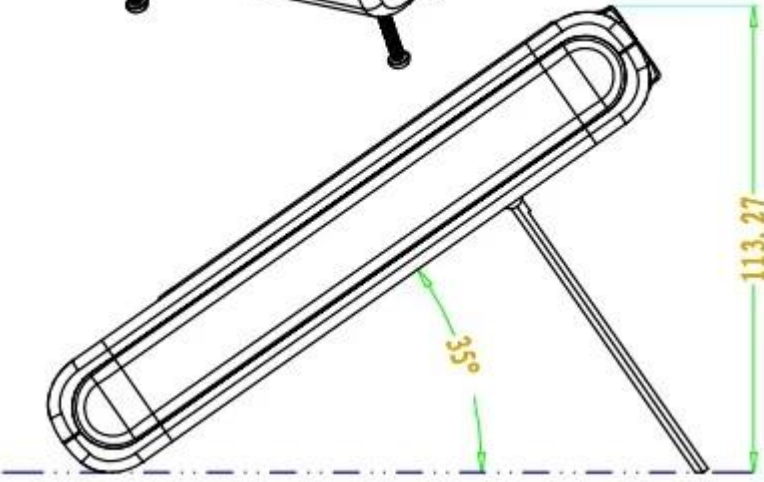

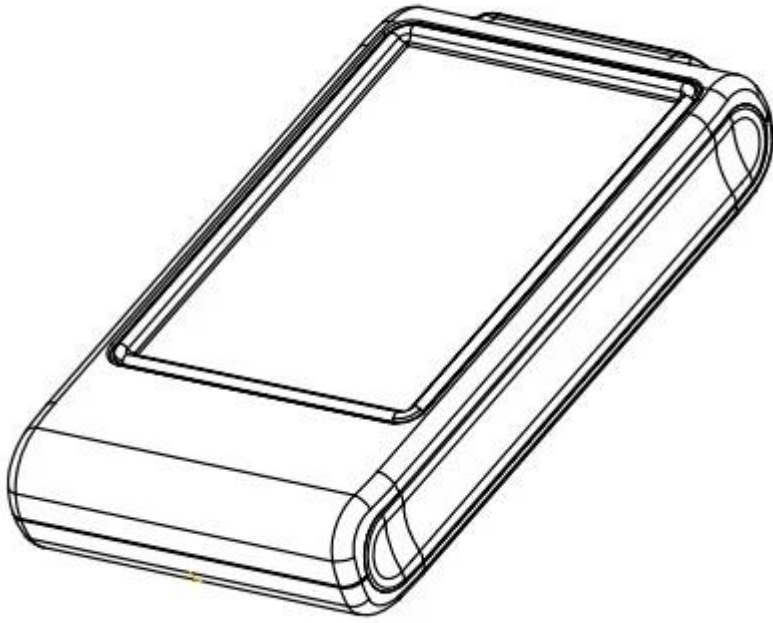



QQ

505924585



Tel

86-755-83222882
86-13028816914



Add

628Room,505 Building ,Shangbu industry,
Hangtian road ,Futian district ,Shenzhen,
China,518031



Email

lily@szomk.net



skype

szomk006