

Descripción del Producto:

1. Número de modelo: AK-S-01
2. Tamaño: 80x50x19mm
3. Color: A1, A2, A6, A8, A9, A11
4. Peso: 24G

SZOMK

**Customizable
Cutout, sticker
Silkscreen, color**



Model No. AK-S-01
Weight :24 g

Size: 3.15*1.97*0.75 inch
80*50*19 mm

▶ Enclosure Manufacturer
www.chinaenclosure.com

SZOMK

*Customizable
Cutout, sticker
Silkscreen, color*



*Model No. AK-S-01
Weight :24 g*

*Size: 3.15*1.97*0.75 inch
80*50*19 mm*

▶ Enclosure Manufacturer
www.chinaenclosure.com

SZOMK

*Customizable
Cutout, sticker
Silkscreen, color*



Model No. AK-S-01
Weight :24 g

Size: 3.15*1.97*0.75 inch
80*50*19 mm

▶ Enclosure Manufacturer
www.chinaenclosure.com

SZOMK

**Customizable
Cutout, sticker
Silkscreen, color**

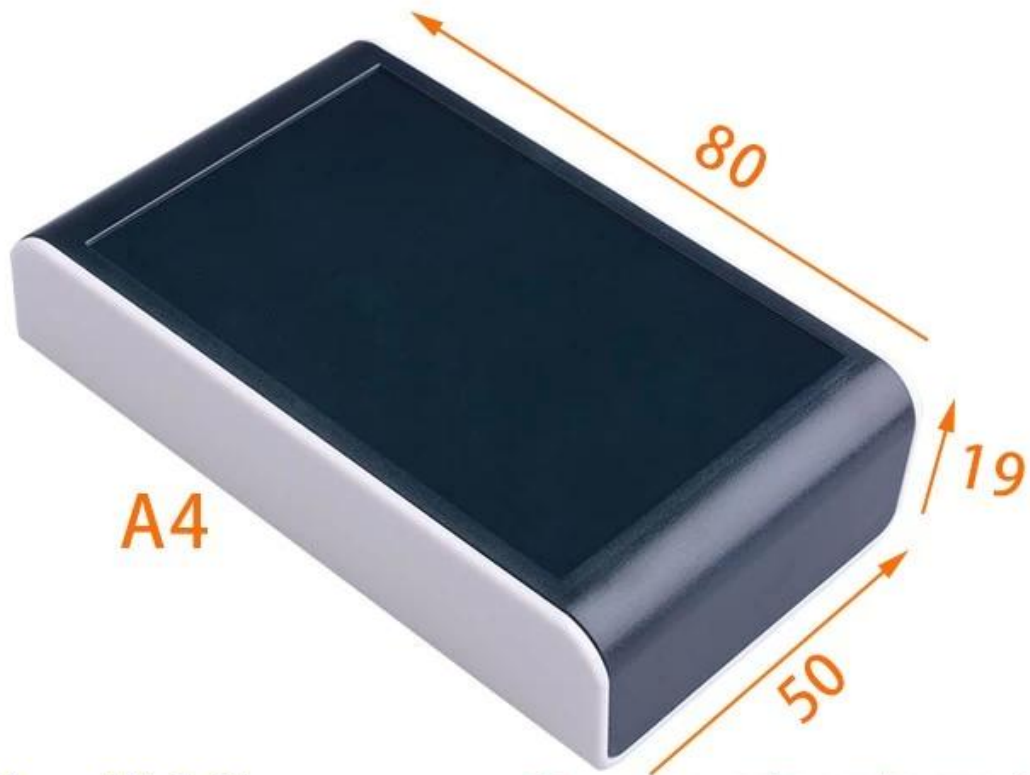

A4

Model No. AK-S-01

Weight :24 g

**Size: 3.15*1.97*0.75 inch
80*50*19 mm**

▶ Enclosure Manufacturer
www.chinaenclosure.com

SZOMK

**Customizable
Cutout, sticker
Silkscreen, color**



Model No. AK-S-01
Weight :24 g

Size: 3.15*1.97*0.75 inch
80*50*19 mm

SZOMK

**Customizable
Cutout, sticker
Silkscreen, color**



Model No. AK-S-01
Weight :24 g

Size: 3.15*1.97*0.75 inch
80*50*19 mm

SZOMK

A6



A2



A1



A8



A9



A11

SZOMK

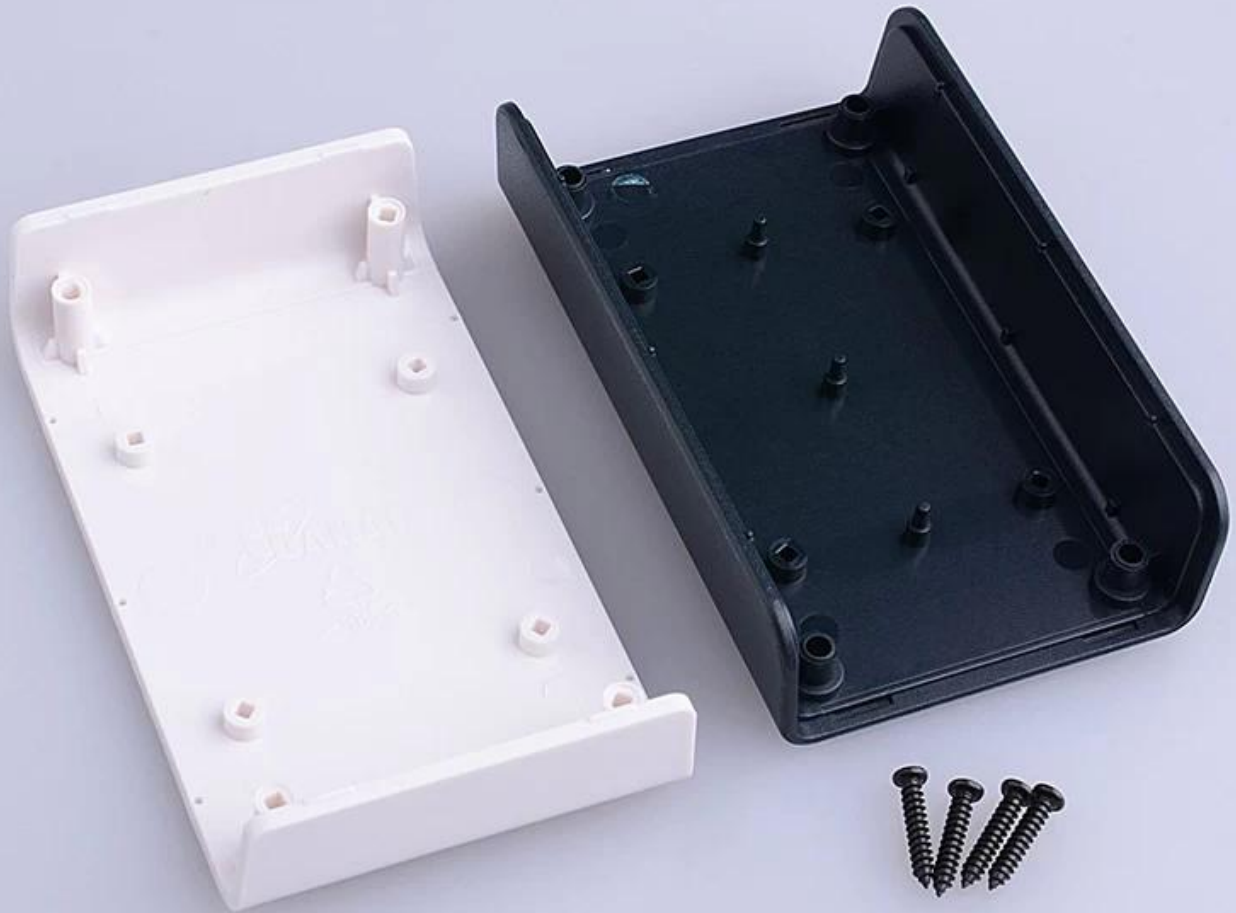

SZOMK



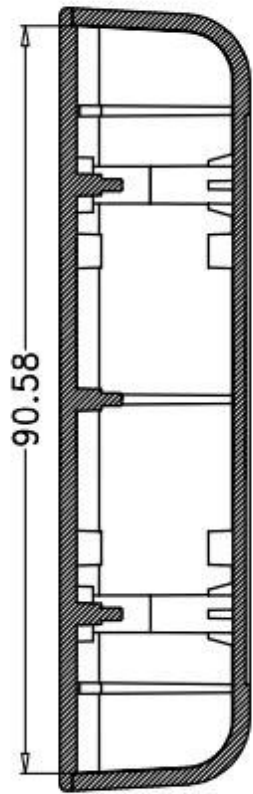

SECTION B-B

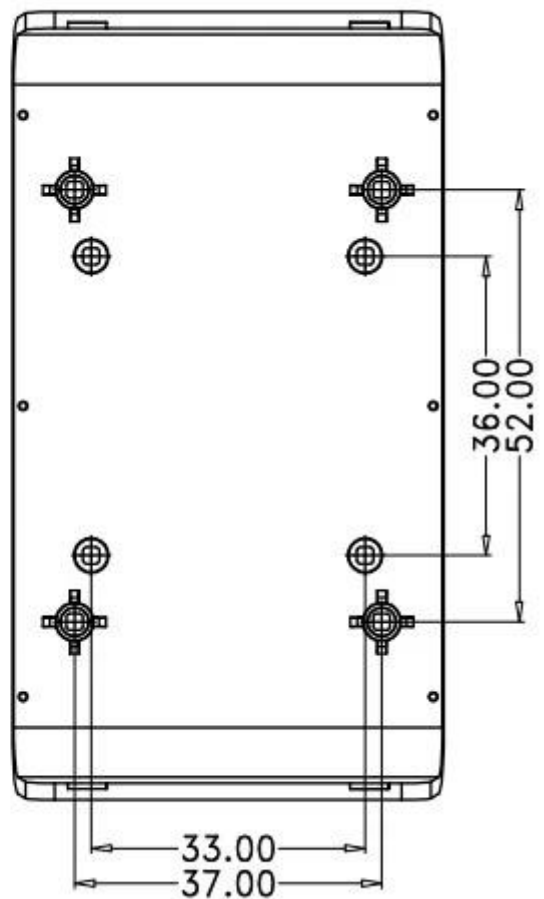
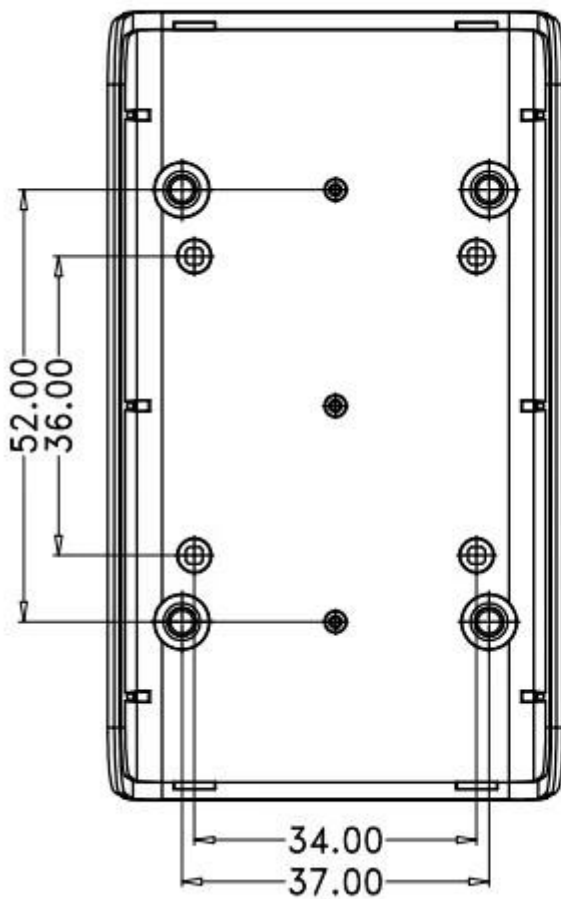
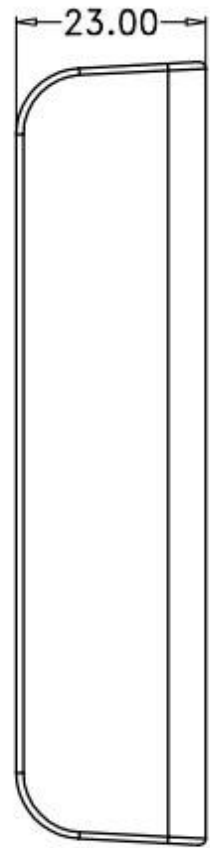
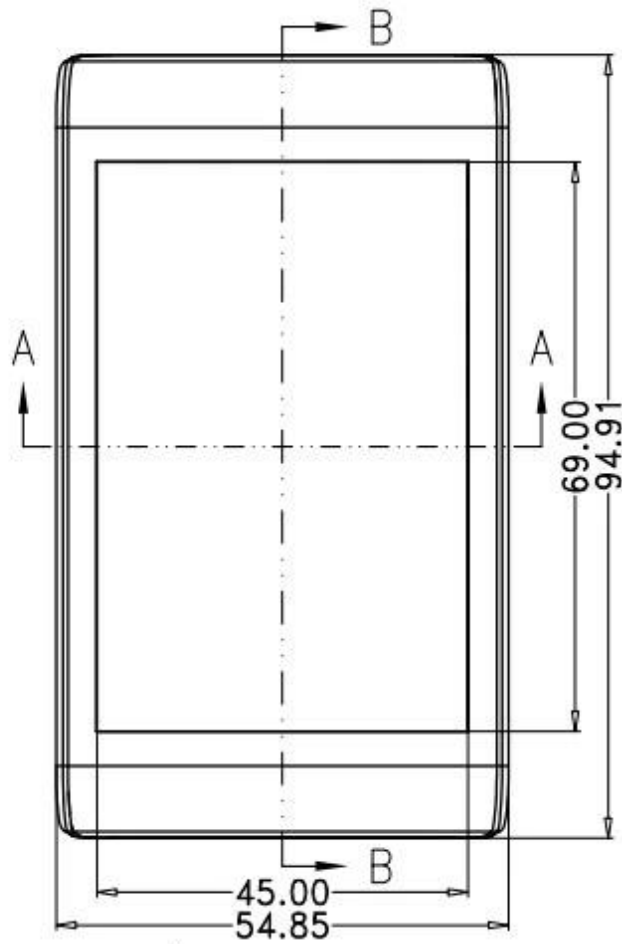

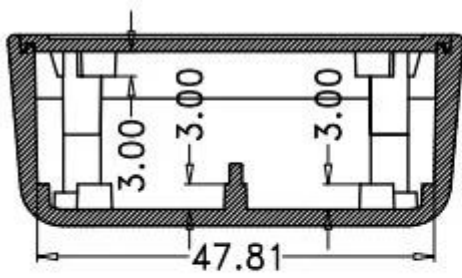

SECTION A-A

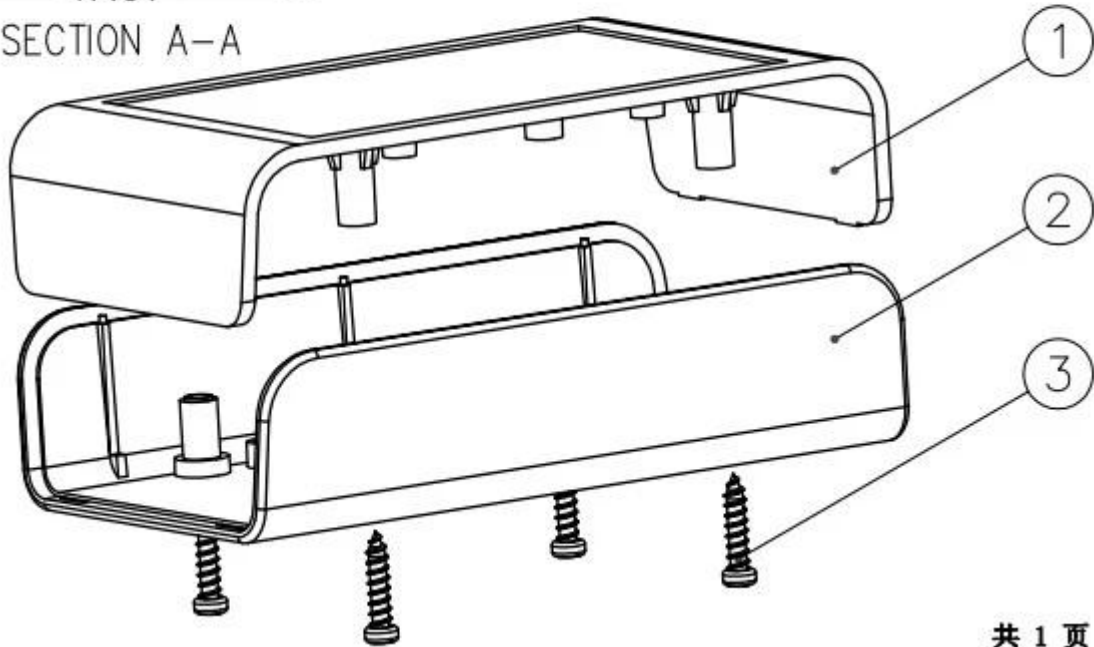

共 1 页

Nuestro servicio personalizado:

1. Cambiar la longitud
2. CAMBIAR COLOR
3. pulido
4. Recubrimiento en polvo
5. Papel de aluminio cepillado.
6. Taladrisimos agujeros
7. Grabado láser
8. Etiqueta de PVC
9. Placa de acrílico
- Pantalla 10.SILK

Company Information



Shenzhen Futian Huaqiang Electronic World OMK Electronic Sales Department

This complex, during long years of efforts with its own experienced group and sole facilities for improvement of productions and promotion of products quality, is now one of the largest suppliers of all kinds of metallic and plastic enclosures in different fields of electronic, electrical, communication, medical, industrial and research projects purposes.

In today's industrial world and with the rapid development of all industries, the need of these products is sensed more than ever. Therefore by offering the best quality and service, we try to meet these needs and help you to reach your ideals.

Exhibition



Certificate



Factory and showroom



Packaging & Shipping



SZOMK

Shenzhen Futian Huaqiang Electronic World OMK Electronic Sales Department

Tel: +86-755-83222882 E-mail: ivy@szomk.com.cn



