

Voici notre service de personnalisation:

- 1, la longueur changement d'aluminium
- 2, changez la couleur de nos boîtes
- 3, produit de polissage
- 4, revêtement en poudre
- 5, l'huile brossé
- 6, découpe
- 7, gravure lasder
- 8, l'étiquette PVC
- 9, plaque acrylique
- 10, l'impression d'écran en soie
- 11, assurez autocollant
- 12, les bords de gel de silice
- 13, sablage
- 14, tréfilage
- 15, protection UV

Utilisez:

Il est largement utilisé dans l'électronique, l'instrumentation, l'automatisation, la communication, unit d'alimentation, projets d'étudiants, amplificateurs, équipement de soins de santé, de l'équipement de test et de mesure, contrôle industriel, les appareils de périphériques et d'interfaces, boîtes de commutation.

Attention:

Bienvenue à nous contacter pour plus de détails et des citations de notre enceinte, votre demande sera sûrement obtenir une réponse rapide en 24 heures: .-)

SZOMK



SZOMK



SZOMK

Customizable
Cutout, sticker
Silkscreen, color



Weight :271 g
Model No. AK-H-34

Size:6.81*3.35*1.97 inch
173*85*50 mm

SZOMK



SZOMK



SZOMK



SZOMK



SZOMK

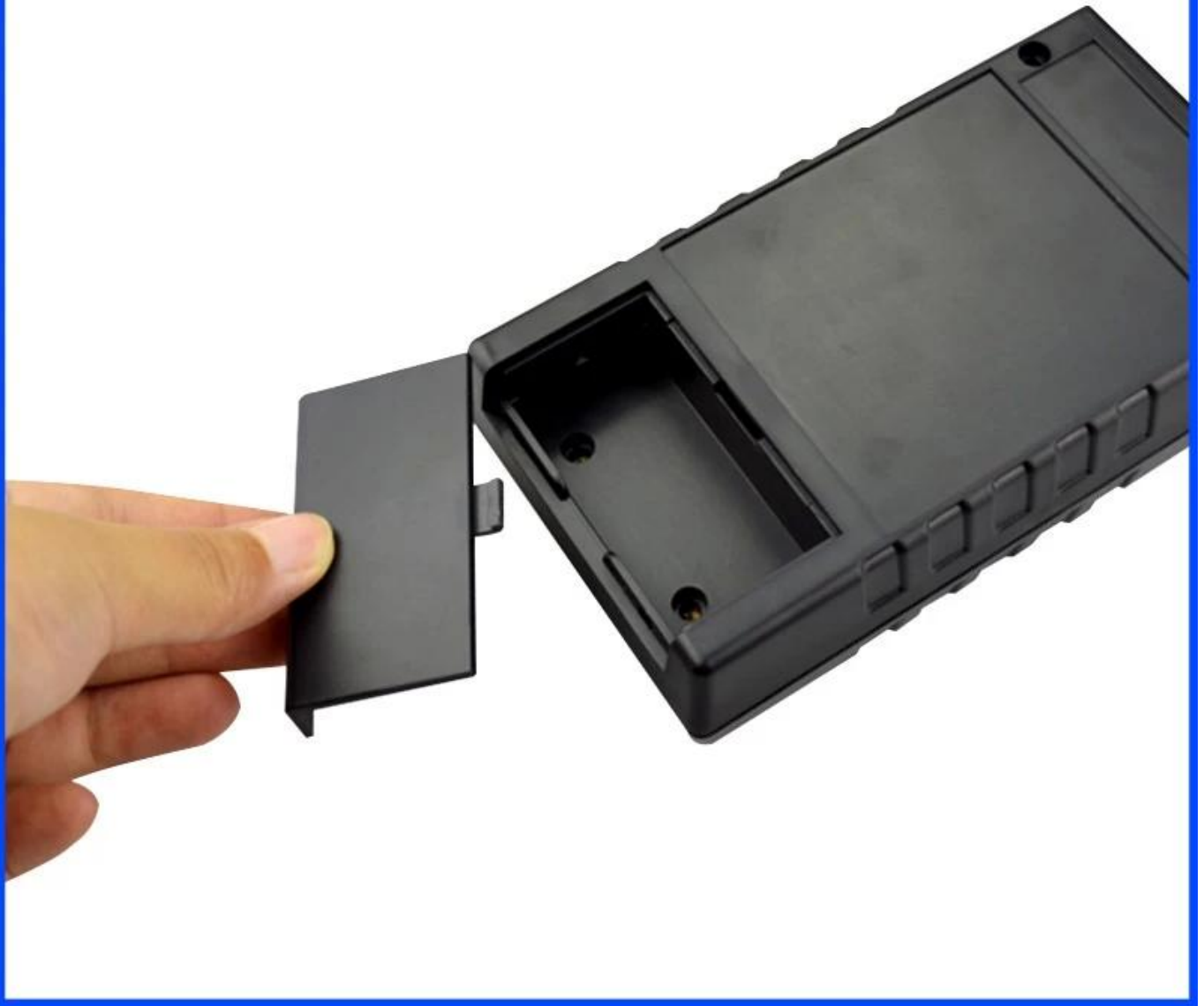

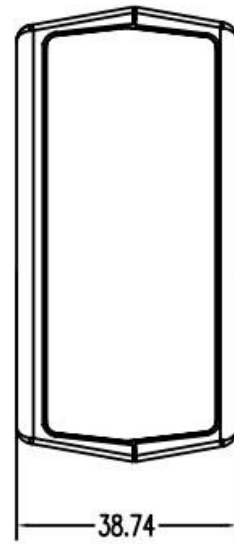
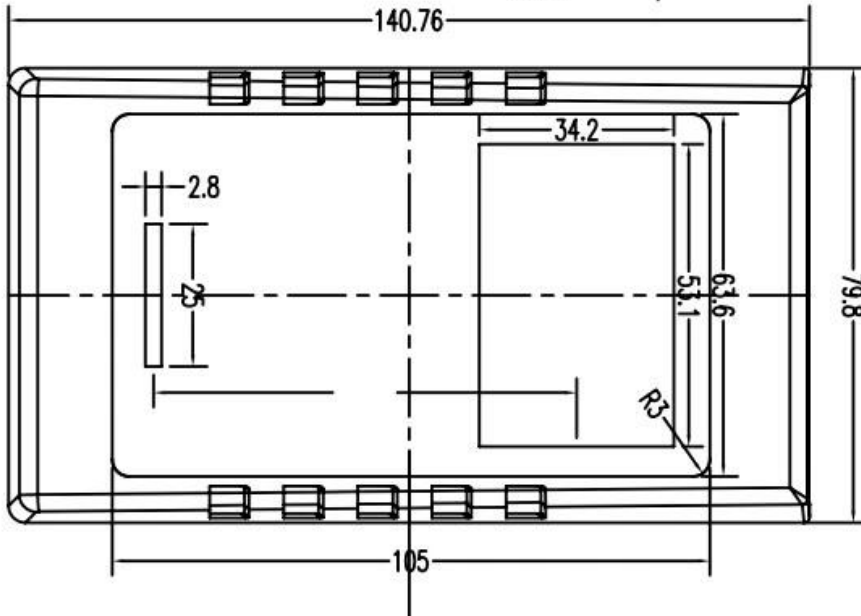
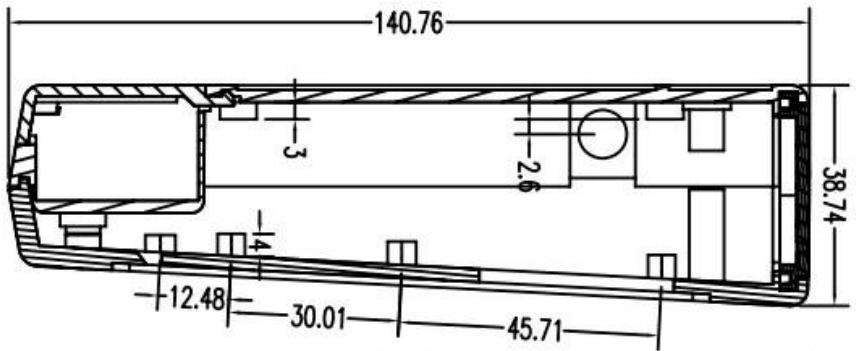

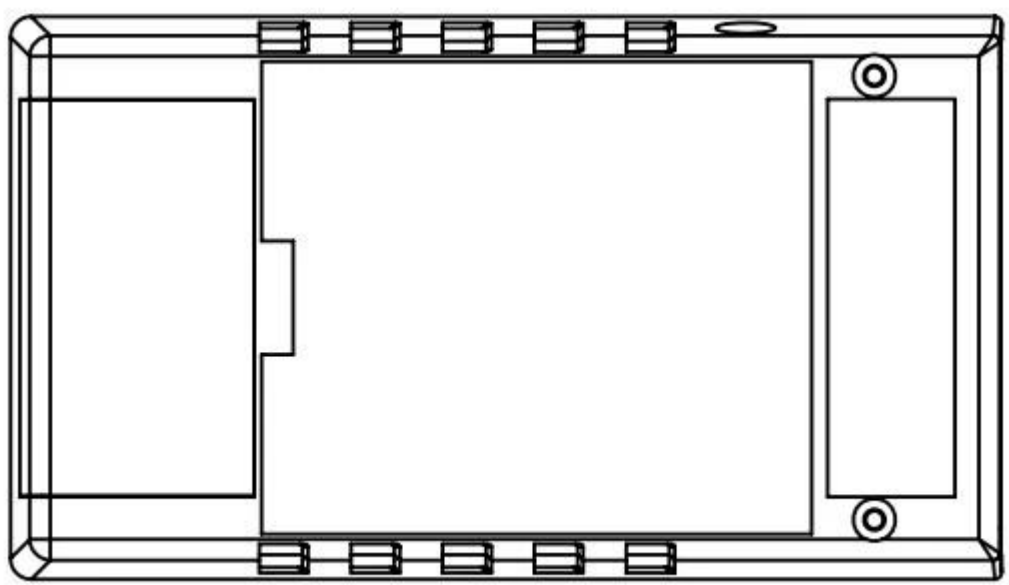
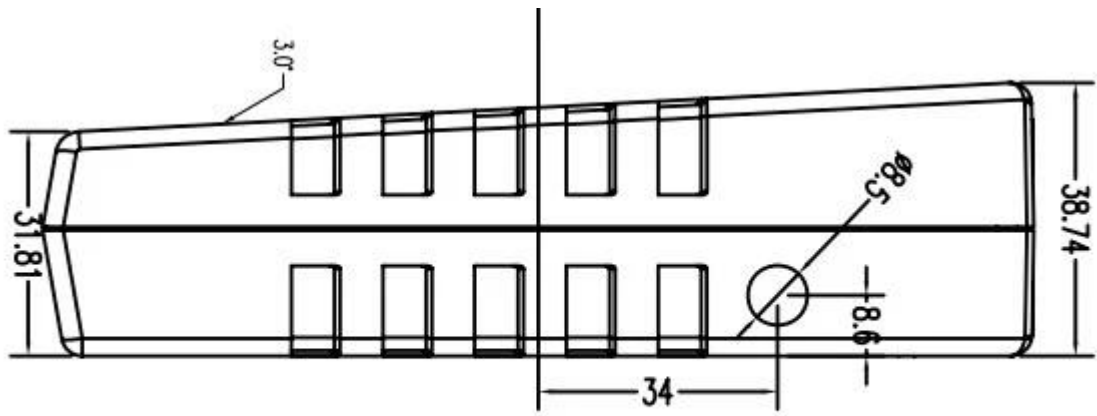

03

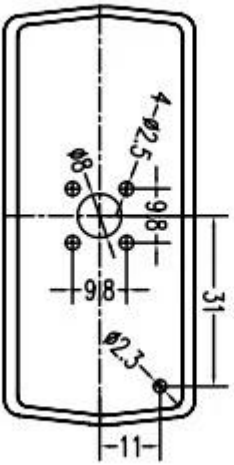

04

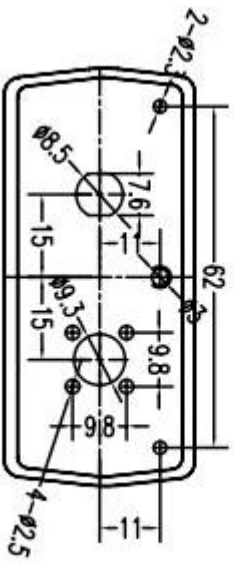

SEC 1-1

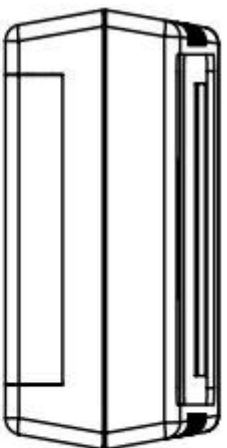

现有挡片开孔尺寸

01

02

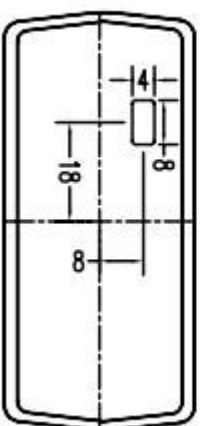



QQ

505924585



Tel

86-755-83222882
86-13028816914



Add

628Room,505 Building ,Shangbu industry,
Hangtian road ,Futian district ,Shenzhen,
China,518031



Email

lily@szomk.net



skype

szomk006