

Vantaggi dell'alloggiamento SZOMK

1. Ha forte resistenza alla corrosione, resistenza agli agenti atmosferici, resistenza alla corrosione.
2. la superficie può essere formata in una varietà di colori, e il massimo per soddisfare le vostre esigenze.
3. Avere una buona robustezza salva l'elettronica.

Che cosa possiamo fare per voi

1 forciando, perforando e così via. Benvenuti nella grafica su richiesta.

2 verniciatura a polvere, pennelli, lucidatura, serigrafia, incisione laser, poster, incisioni, pannello in resina acrilica.

3 tempi di consegna brevi, solitamente dopo 3-5 giorni dopo il pagamento (in base al numero)

4 consigli per la tua richiesta

specificazione del prodotto



SZOMK

Customizable
cutout, sticker
silkscreen, color



Weight: 52g
Model No. AK-S-03

Size: 4.33*2.56*1.10 inch
110*65*28 mm

SZOMK

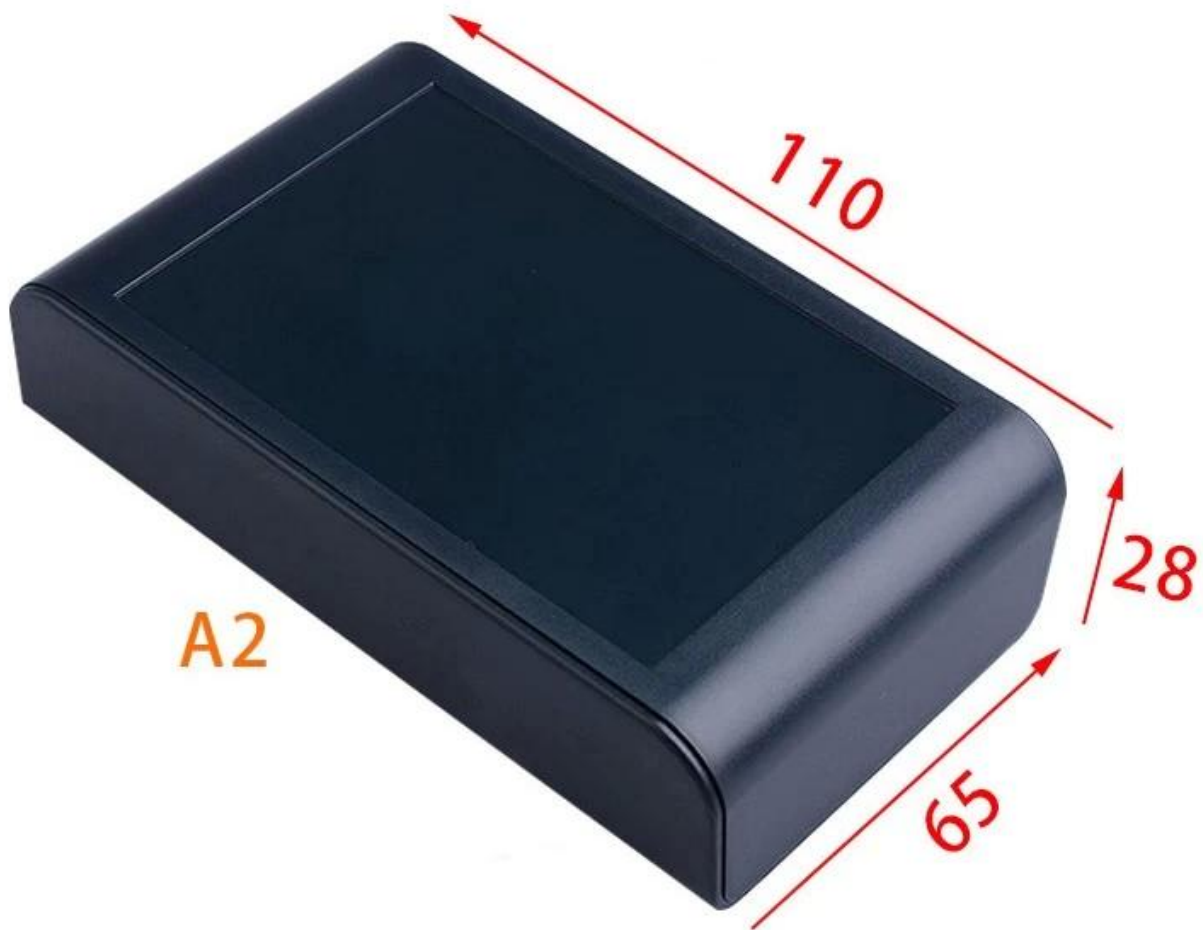

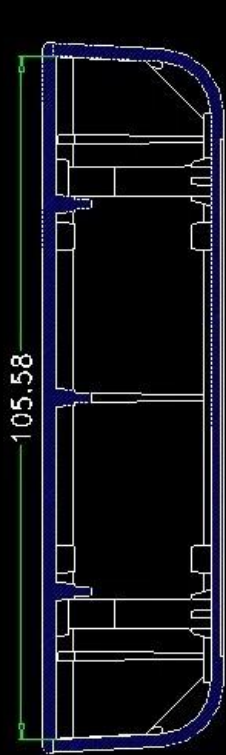

SECTION B-B

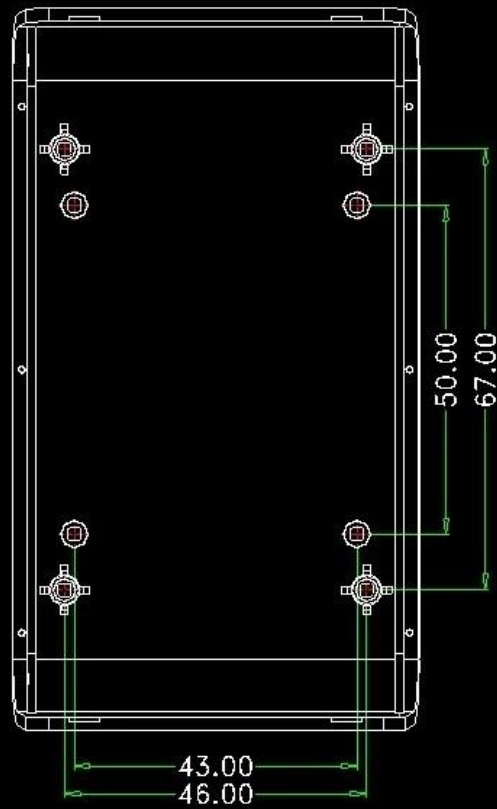
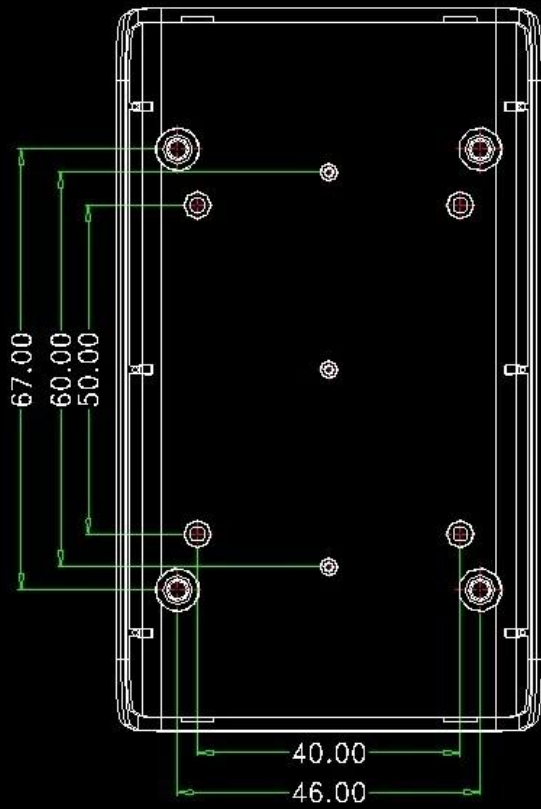
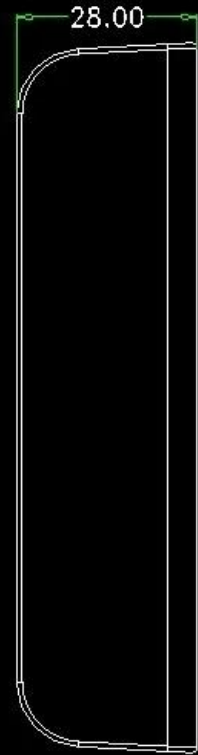
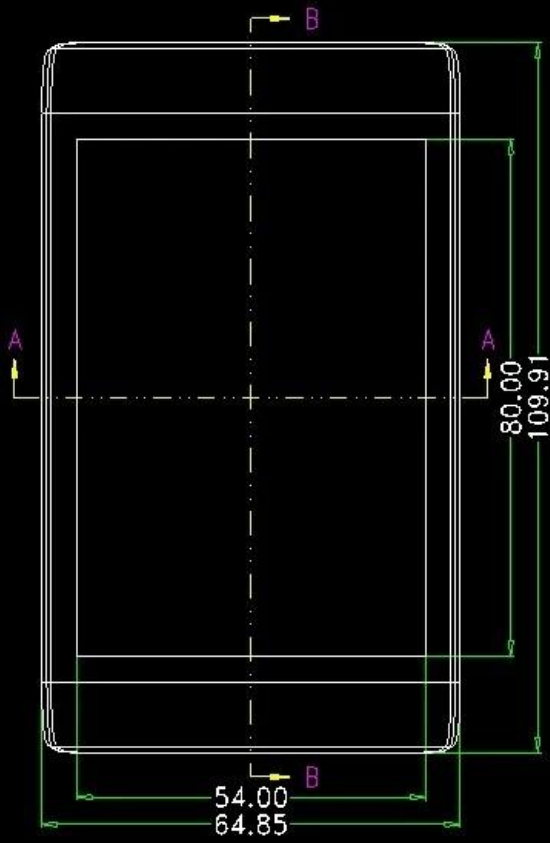

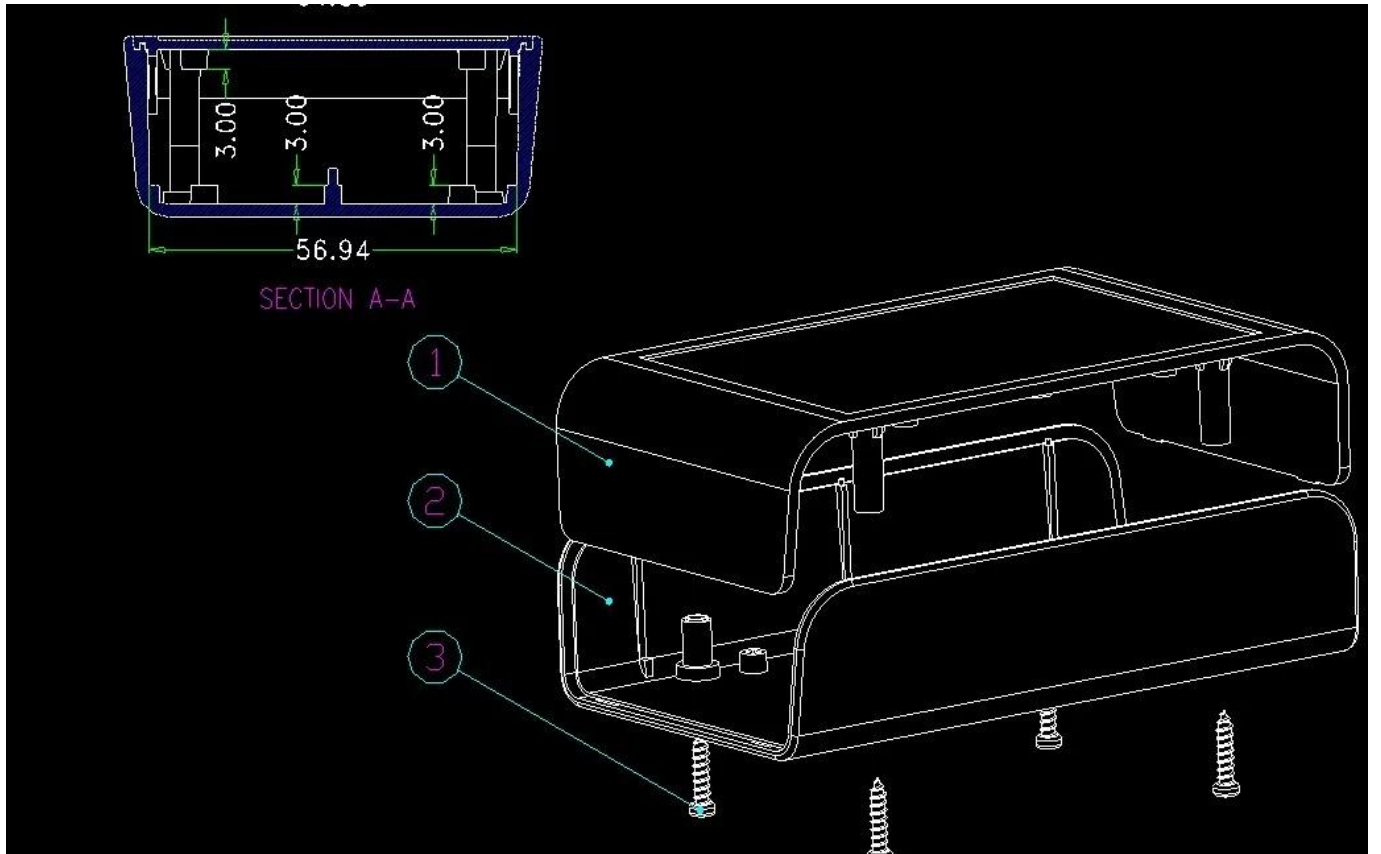

Servizi personalizzati



Company Information



Shenzhen Futian Huaqiang Electronic World OMK Electronic Sales Department

This complex, during long years of efforts with its own experienced group and sole facilities for improvement of productions and promotion of products quality, is now one of the largest suppliers of all kinds of metallic and plastic enclosures in different fields of electronic, electrical, communication, medical, industrial and research projects purposes.

In today's industrial world and with the rapid development of all industries, the need of these products is sensed more than ever. Therefore by offering the best quality and service, we try to meet these needs and help you to reach your ideals.

Factory and showroom



Exhibition



Certificate



Packaging & Shipping



Informazioni sui contatti



QQ

2110283100



Tel

81-755-83222882
+86 18819074698



Add

16-6Floor, 505Building ,Shangbu Industry
Area, Hangtian RD, Futian District ,Shenzhen
China



Email

teddy@szomk.net



skype

teddy@szomk.net



WeChat

teddy07277