



□□□□□□□□□□

□□□□□□□□□□□□□□□□□□□□□□□□

□□□□□ **AK-S-103**

□□□□ **81 * 41 * 51** □□□□□□

□□□ **abs** □□□□□□

□□□□ **MOQ** □ **1** □

□□□□□□□□□□□□ □□□□□□□□□□□□□□□□□□□□□□□□□□□□□□□□□□□□□□□
□□□□□□□□□□□□

□□□□□□□□□□ **MOQ** □ **20** □

□□□□□□□□□□

SZOMK



▶ **Enclosure Manufacturer**
www.chinaenclosure.com

SZOMK

Customizable
cutout, sticker
silkscreen, color



Weight: 20g
Model No. AK-S-103

Size: 3.19*1.61*0.59 inch
81*41*15 mm

SZOMK



SZOMK

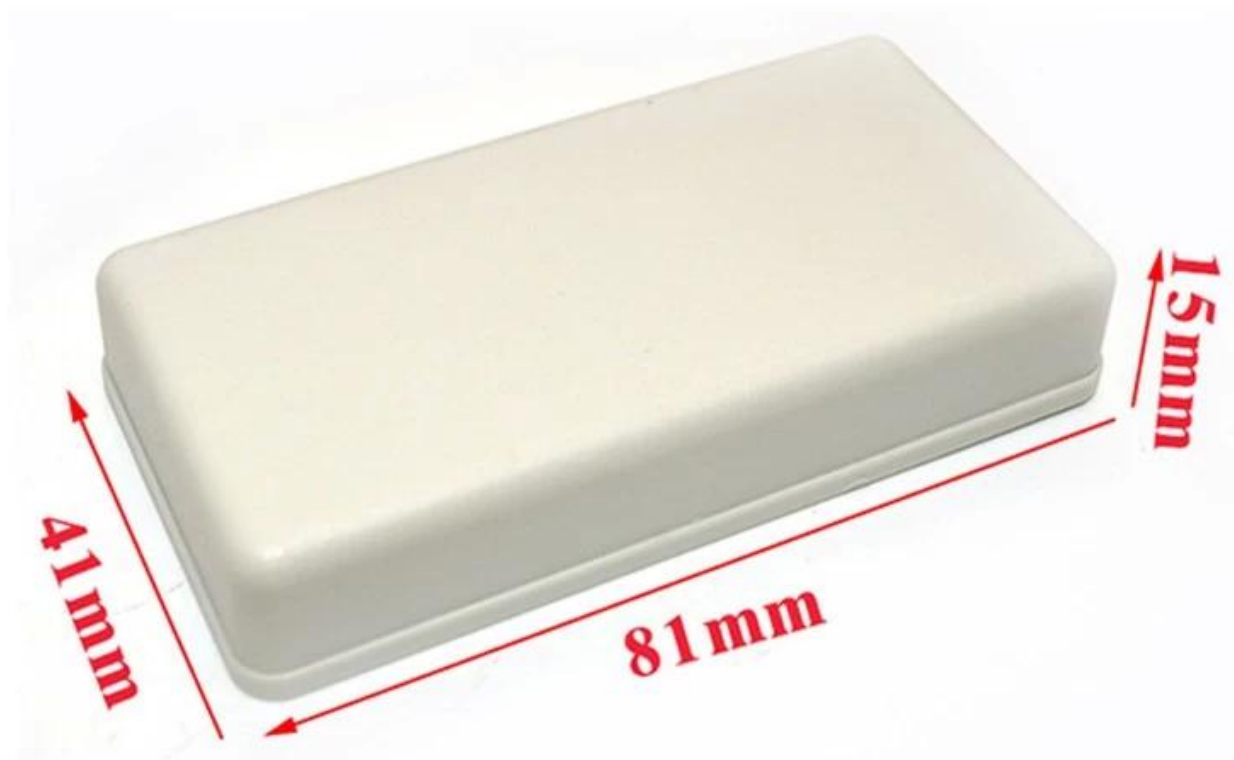

SZOMK

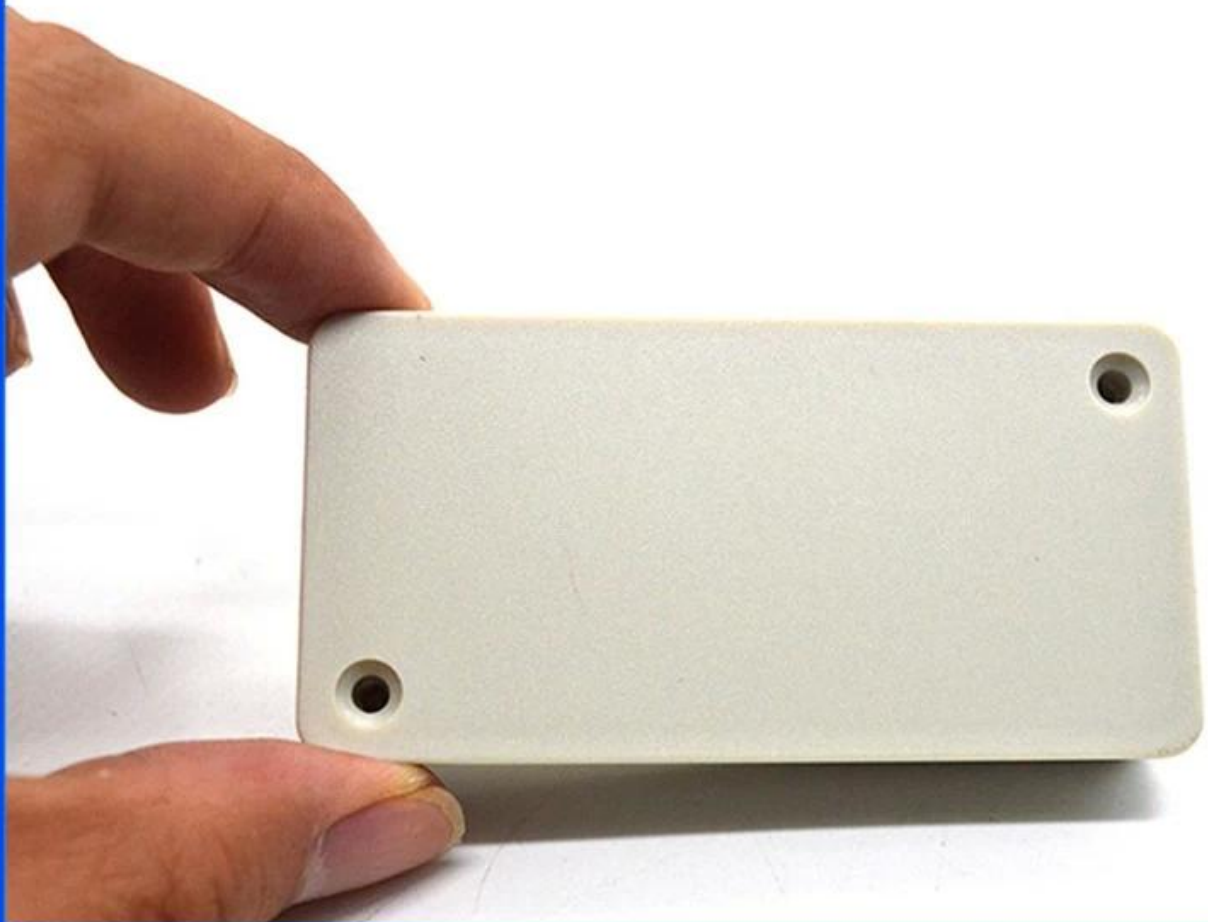

SZOMK



SZOMK



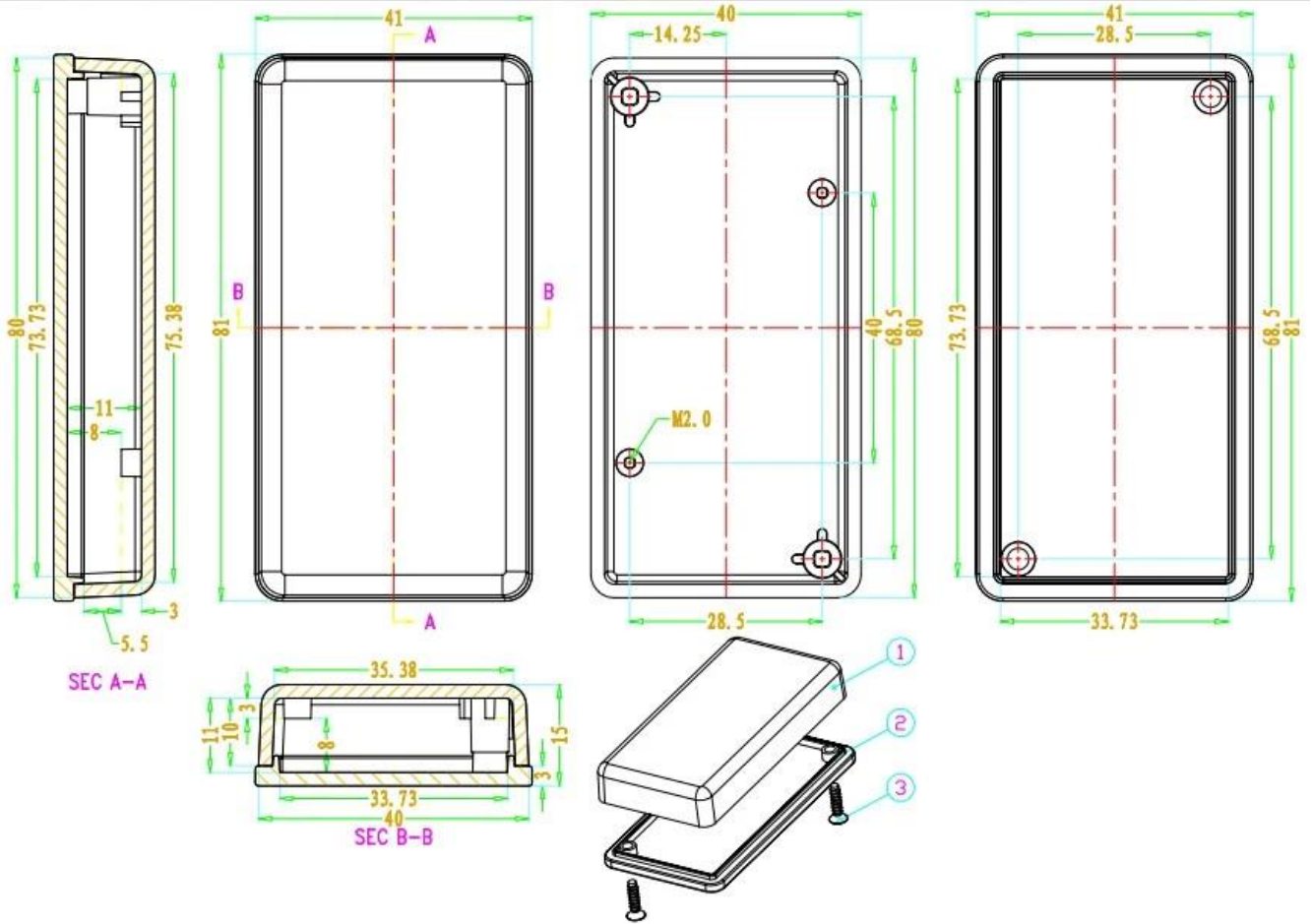

□□□□□□□□□□□□□□□□□□□□□□

- 1□□□□□□□□□□□□□□□□ 2□□□□□□□□□□□□□□□□
- 3□□□□□□ 4□□□□□□
- 5□□□□□□□□□□□□□□□□ 6□□□□□□□□□□□□
- 7□□□□□□□□□□□□□□□□ 8□PVC□□□□□□□□□□□□
- 9□□□□□□□□□□□□□□□□ 10□□□□□□□□□□□□□□□□
- 11□□□□□□□□□□□□□□□□ 12□□□□□□□□□□□□□□□□
- 13□□□□□□□□□□□□□□□□ 14□□□□□□□□□□□□
- 15□UV□□□□□□□□□□□□□□□□ 16□□□□□□□□□□□□□□□□

What we can do (we can do customize)



- 1, change aluminum length
- 2, change color of our boxes
- 3, product polishing
- 4, powder coating
- 5, brushed oil



- 6, cut-out
- 7, laser engraving
- 8, PVC label
- 9, Acrylic plate
- 10, silk screen printing



- 11, make sticker
- 12, silica gel edges
- 13, sandblasting
- 14, wire drawing
- 15, UV protection



Plate



Silkscreen



Sticker

*We can do
customize*

Cutout



Color



Silicone Seals



We can do customize

Cut holes
Silkscreen
Sticker

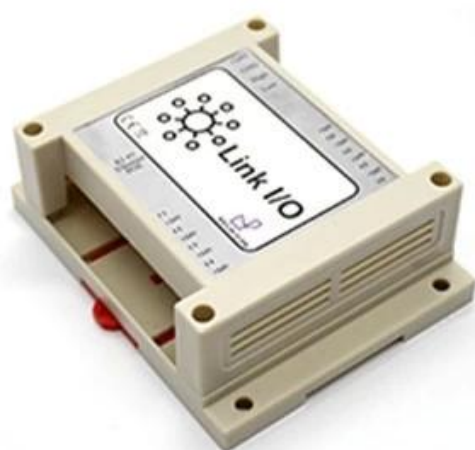

We can do customize

change the color



We can do customize

PVC lable
Acrylic plate
Sticker



We can do customize

Cut holes
Silkscreen
Laser carve



We can do customize



**UV
Protection**



We can do customize

Cut holes
Silkscreen
Sticker

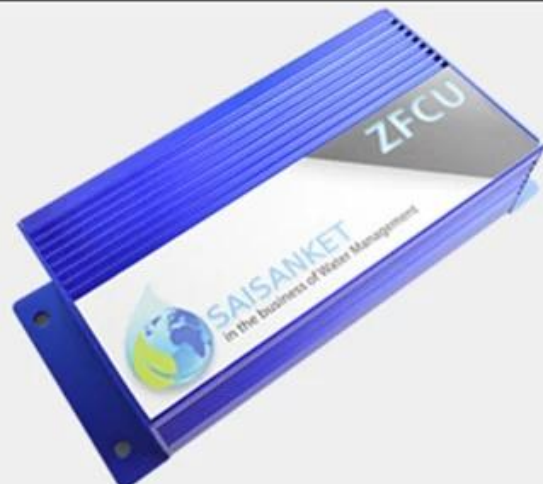

We can do customize



Polishing
Color

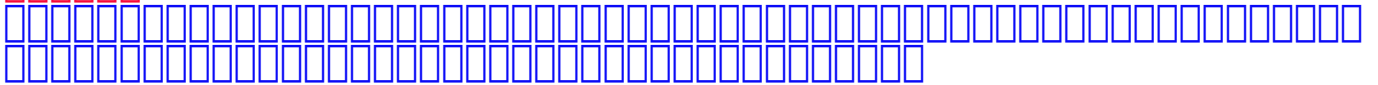

It is widely used in electronic, instrumentation, automation, communications, power supply units, student projects, amplifiers, Medical and wellness devices, test and measurement equipment, industrial control, peripheral devices and interfaces, switch boxes.





QQ

505924585



Tel

86-755-83222882
86-13028816914



Add

616Room,505 Building ,Shangbu industry,
Hangtian road ,Futian district ,Shenzhen,
China,518031



Email

lily@szomk.net



skype

szomk006



WhatsApp

86-13028816914



Contact us if you need to pay by Paypal, T/T, Western Union, Alipay, Cash, Wechat, or Trade Assurance. We will make proforma invoice for you.

For more quantity of our products, leave message or email

lily@szonk.net

for best shipping cost via DHL、Fedex.



ABOUT US

SHENZHEN OKM ELECTRONICS CO.,LTD is now one of the largest suppliers of all kinds of plastic and metallic enclosures in different fields of electronic,electrical,communication,medical,industrial and research projects purposes. We have more than 1000 moulds ,and we can do cutout,silkscreen ,label ,sticker ,laser carve and creat a new mould for you In today's industrial world and with the rapid development of all industries,the need of these products is sensed more than ever. Therefore by offering the best quality and service,we try to meet these needs and help you to reach your ideals.



GROUP PHOTO



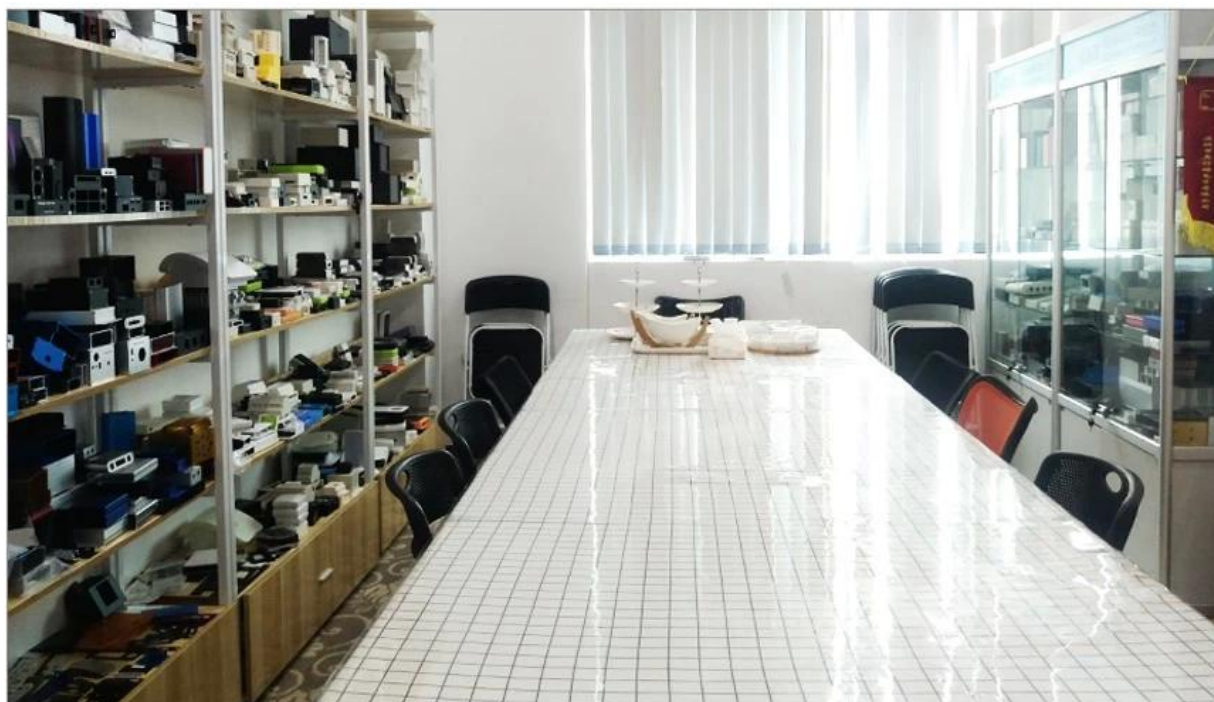

cutout, laser engrave, screen printing, sticker, acrylic plate, pvc label, color, silica gel rings, etc.



PACJAGUBG PROCESS



☐☐☐☐☐☐☐☐ lily@szomk.net ☐☐☐☐☐☐☐☐

☐☐☐☐☐☐☐☐☐☐ 24 ☐☐☐☐☐☐☐☐☐☐ ☐o☐

