

□□□ □□□ □□□ □□ □□□□ □□□ □□□□

1. □□□ □□
2. □□ □□
3. □□
4. □□
5. □□ □□□□ □□
6. □□ □□
7. □□□ □□
8. PVC □□
9. □□□ □
- (10) □□

□□

□□□ □□ □□, □□, □□□, □□, □□ □□ □□ □□, □□ □□□□, □□, □□ □□, □□□ □ □□ □□, □□ □ □□, □□ □□ □ □□□□□□ □□□□, □□□ □□.

□□ :

□□□ □□□ □□□ □□□□□ □□□ □□ □□□ □□ □□ □□□□□, □□□ 24 □□ □□□□ □□□ □□ □□ □□□ .-)

SZOMK

Customizable
Cutout, sticker
Silkscreen, color



Weight :189 g
Model No. AK-H-36

Size:6.73*3.86*1.22 inch
171*98*31 mm

SZOMK

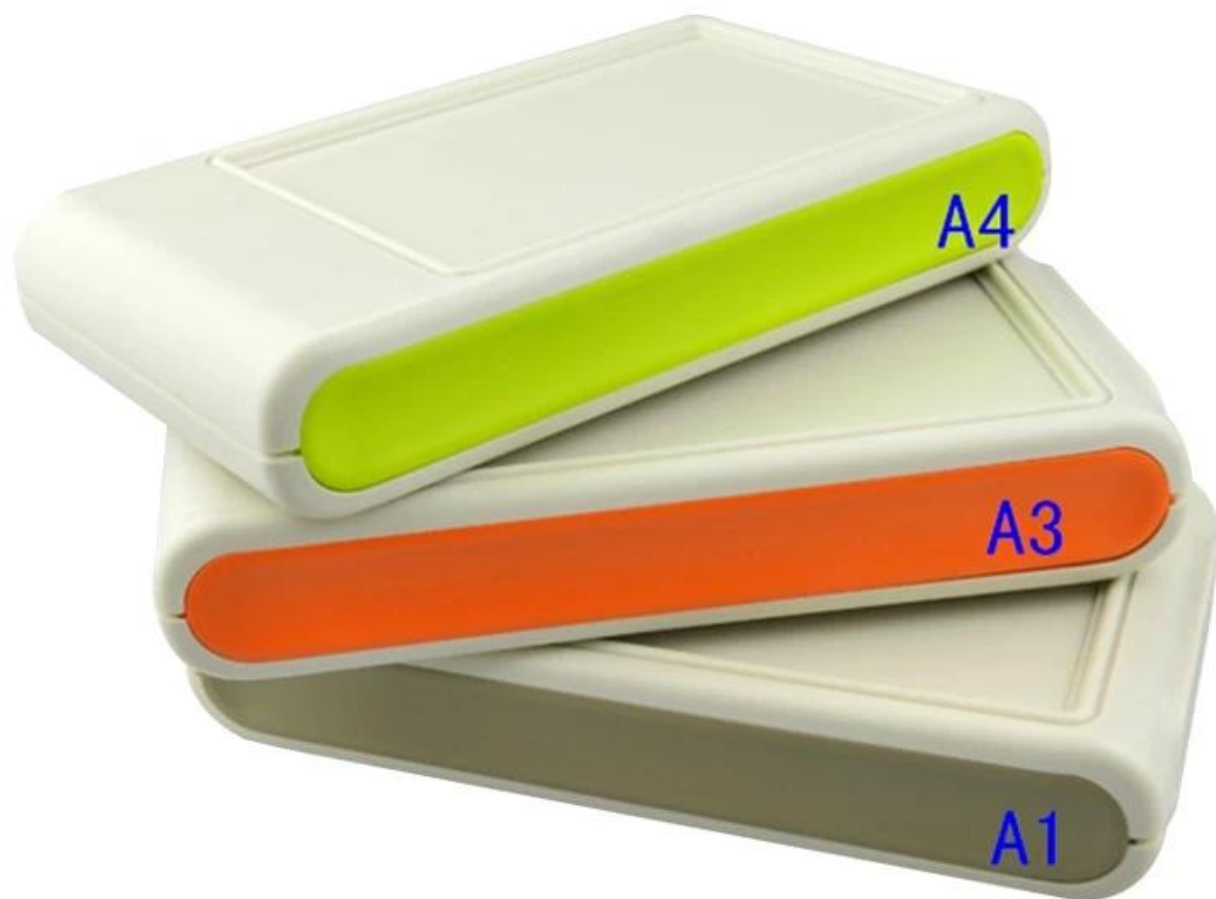

SZOMK

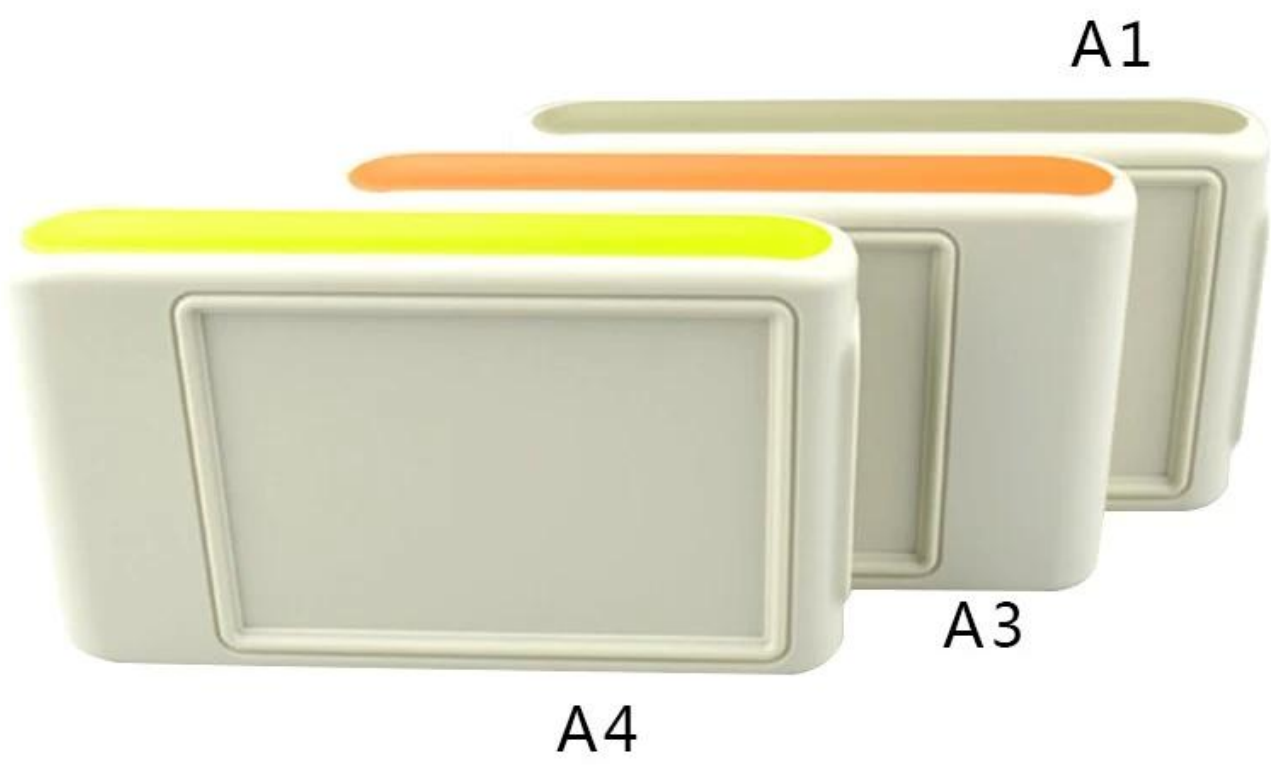

SZOMK



SZOMK



SZOMK

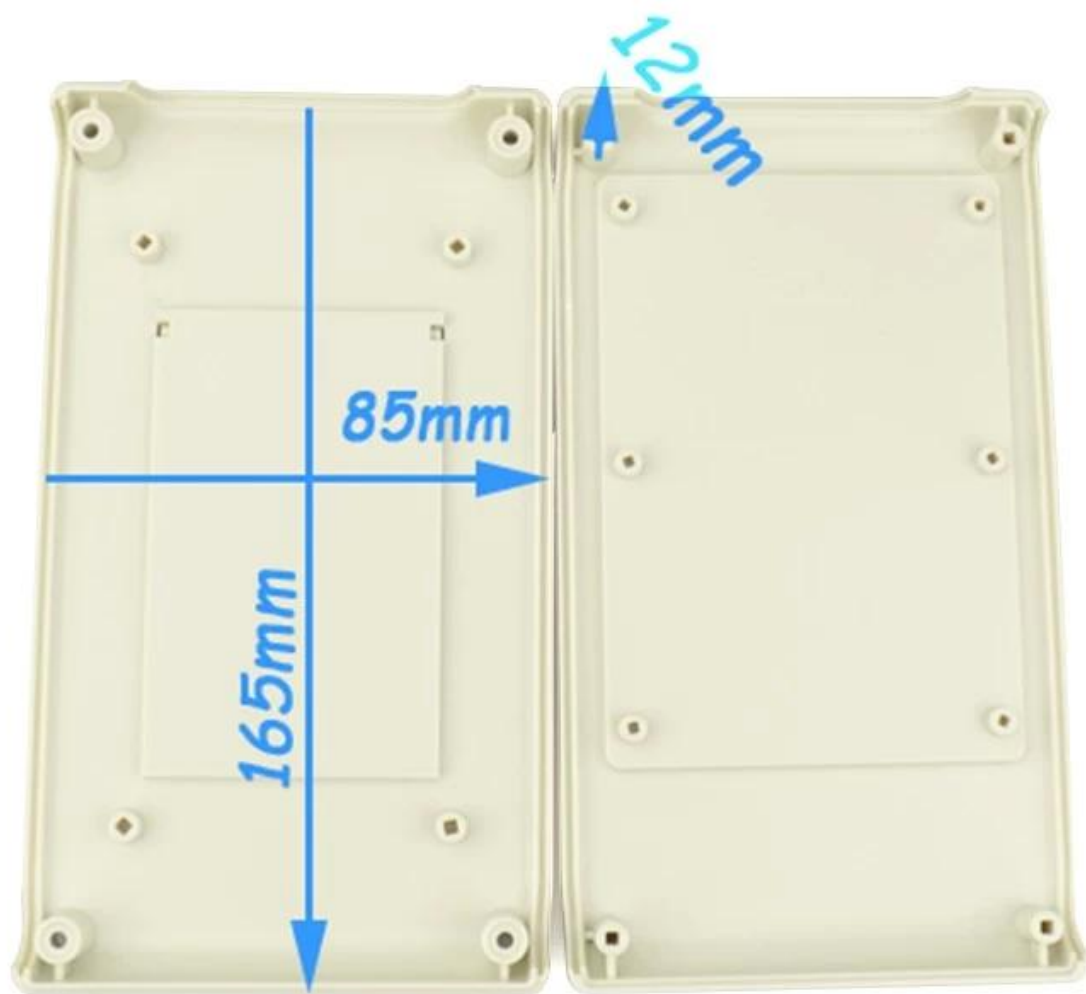

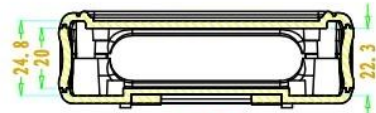
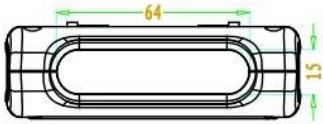

SEC B-B

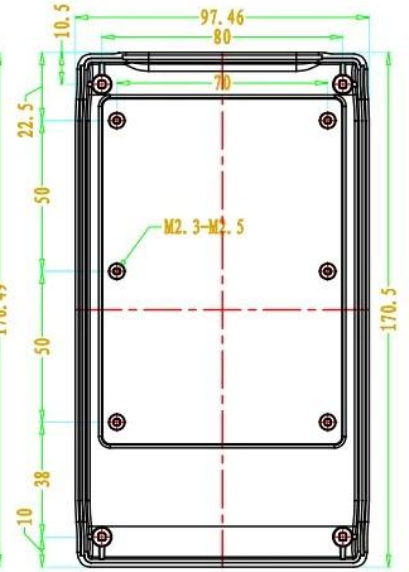
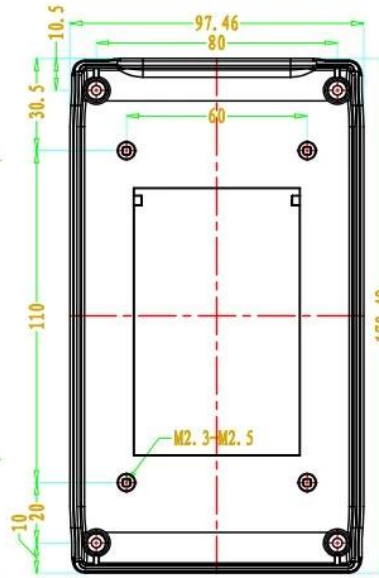
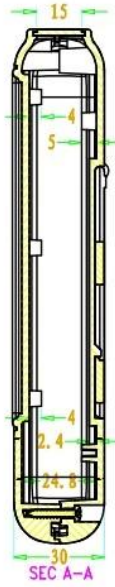
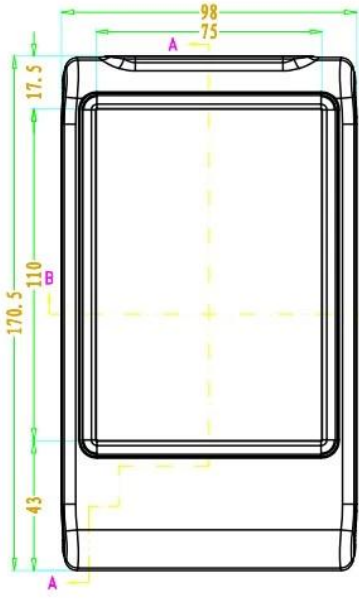

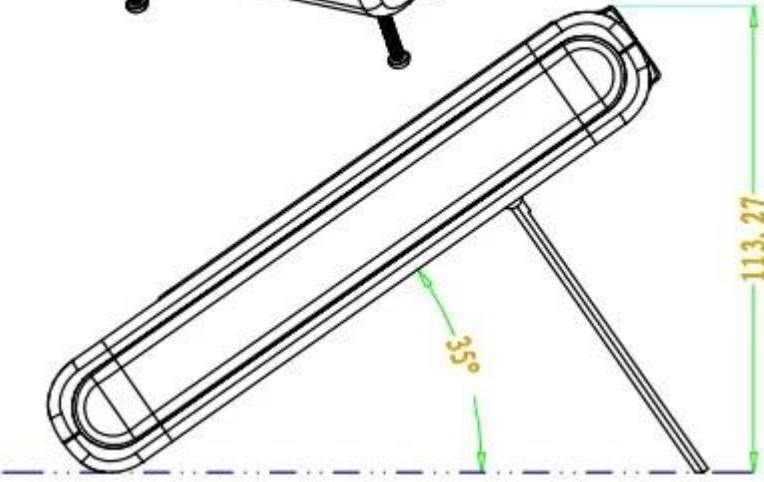

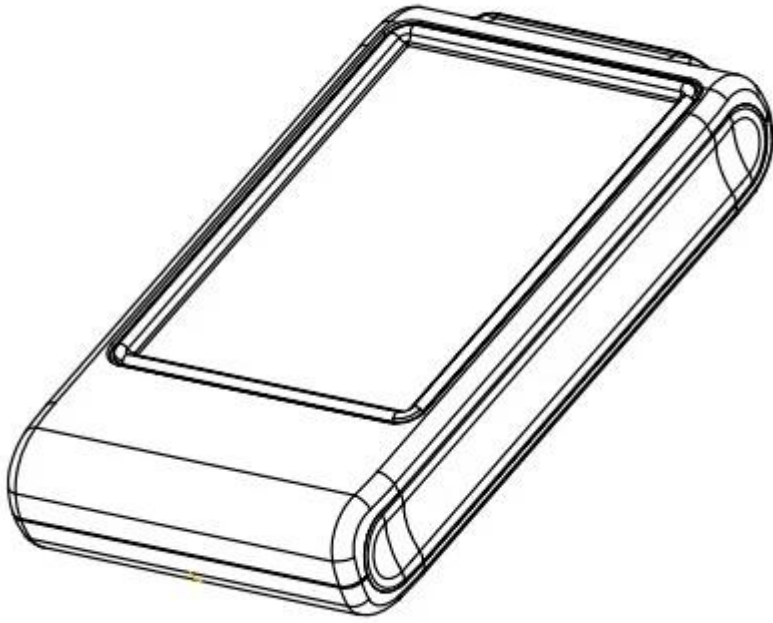



QQ

505924585



Tel

86-755-83222882
86-13028816914



Add

628Room,505 Building ,Shangbu industry,
Hangtian road ,Futian district ,Shenzhen,
China,518031



Email

lily@szomk.net



skype

szomk006