

□□□ □□□ □□□ □□ □□□□ □□□ □□□□

1. □□□ □□
2. □□ □□
3. □□
4. □□
5. □□ □□□□ □□
6. □□ □□
7. □□□ □□
8. PVC □□
9. □□□ □
- (10) □□

□□

□□□ □□ □□, □□, □□□, □□, □□ □□ □□ □□, □□ □□□□, □□, □□ □□, □□□ □ □□ □□, □□ □□□, □□ □□ □ □□□□□□ □□□□, □□□ □□.

□□ :

□□□ □□□ □□□ □□□□□ □□□ □□ □□□ □□ □□ □□□□□, □□□ □□□ 24 □□ □□□ □□□ □□ □□□. :-)

SZOMK

**Customizable
Cutout, sticker
Silkscreen, color**

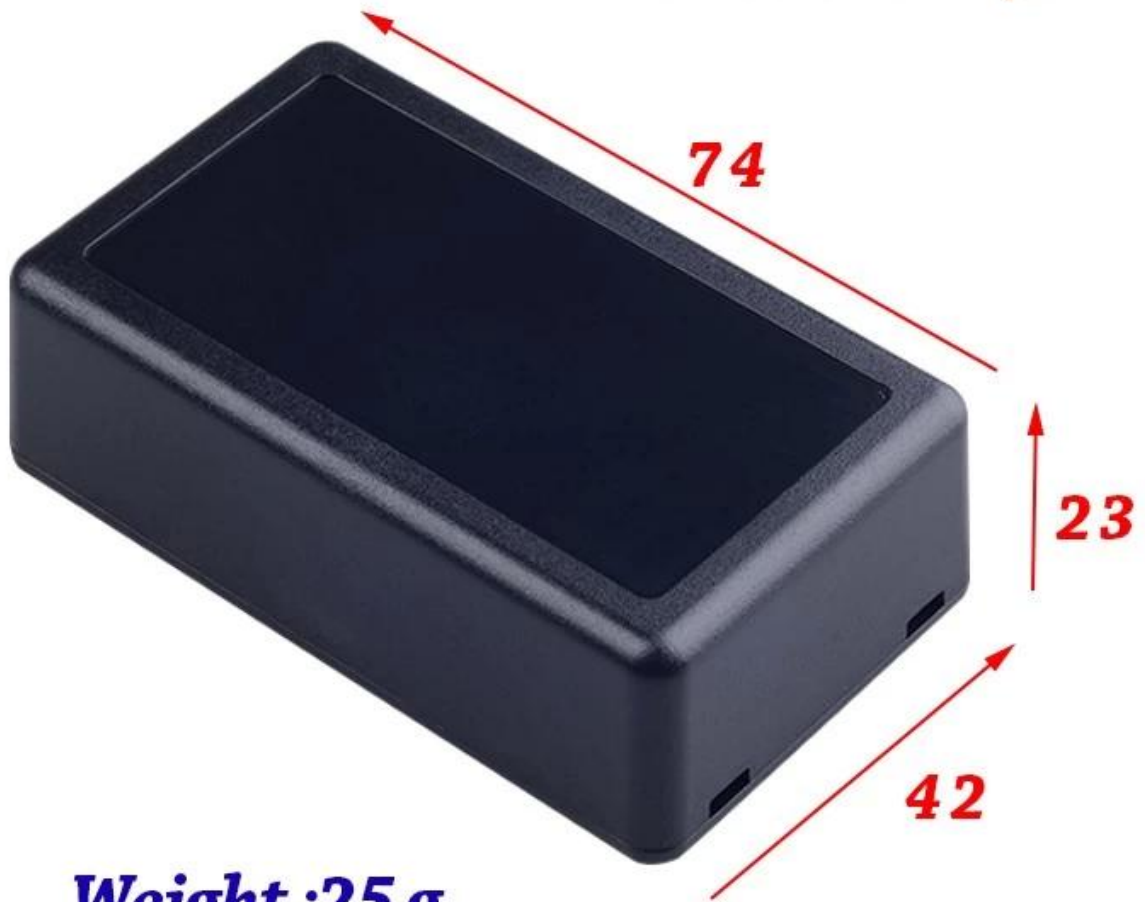

Weight :25 g

Model No. AK-S-15

74*42*23 mm

Size:2.91*1.65*0.91 inch

SZOMK



SZOMK



SZOMK



SZOMK



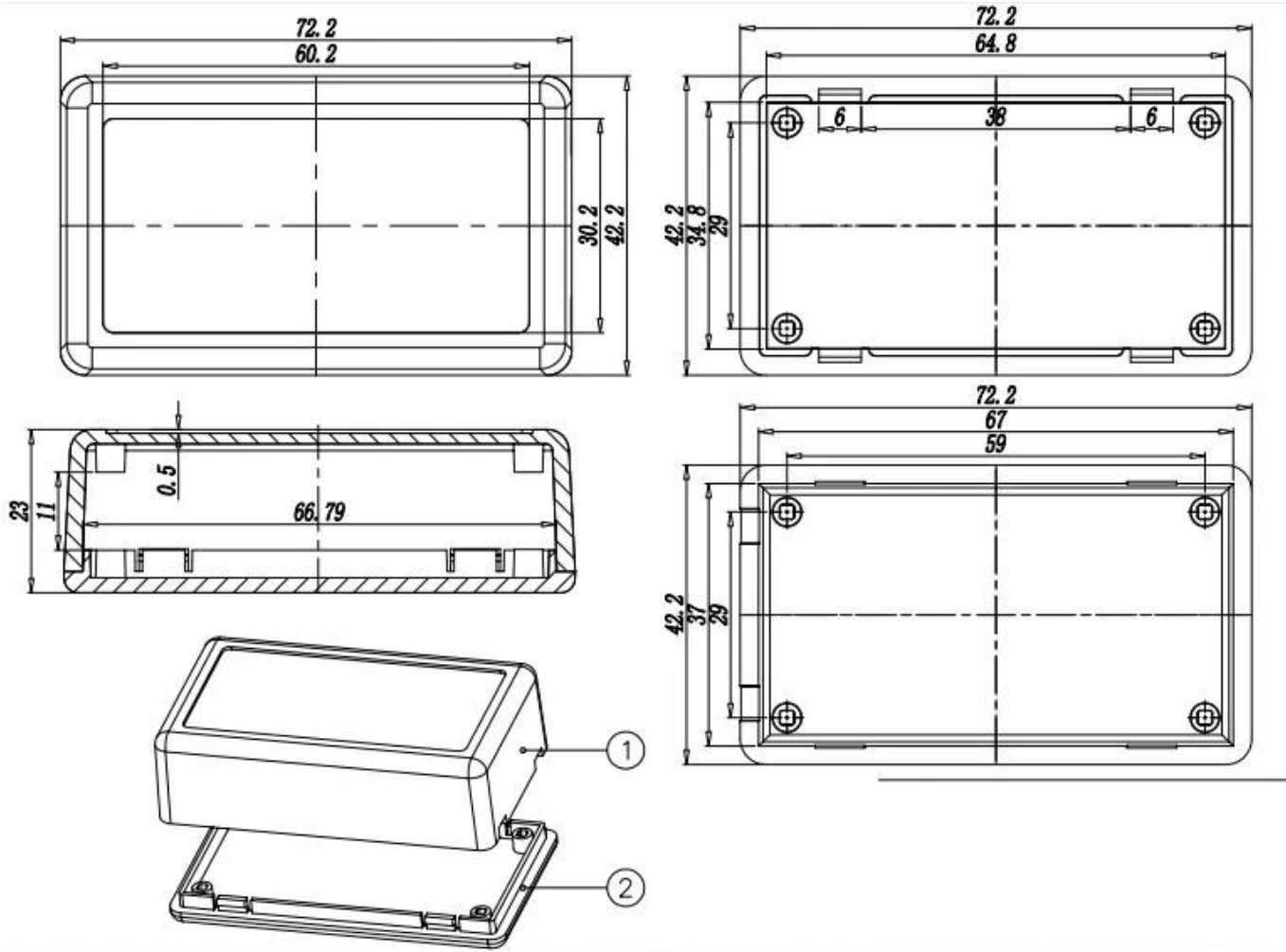



QQ

505924585



Tel

86-755-83222882
86-13028816914



Add

628Room,505 Building ,Shangbu industry,
Hangtian road ,Futian district ,Shenzhen,
China,518031



Email

lily@szomk.net



skype

szomk006