

□□□ □□□ □□□ □□ □□□□ □□□ □□□□

1. □□□ □□
2. □□ □□
3. □□
4. □□
5. □□ □□□□ □□
6. □□ □□
7. □□□ □□
8. PVC □□
9. □□□ □
- (10) □□

□□

□□□ □□ □□, □□, □□□, □□, □□ □□ □□ □□, □□ □□□□, □□, □□ □□, □□□ □ □□ □□, □□ □□□, □□ □□ □ □□□□□□ □□□□, □□□ □□.

□□ :

□□□ □□□ □□□ □□□□□ □□□ □□ □□□ □□ □□ □□□□□, □□□ □□□ 24 □□ □□□ □□□ □□ □□□. :-)

**SZOMK**

**Customizable  
Cutout, sticker  
Silkscreen, color**

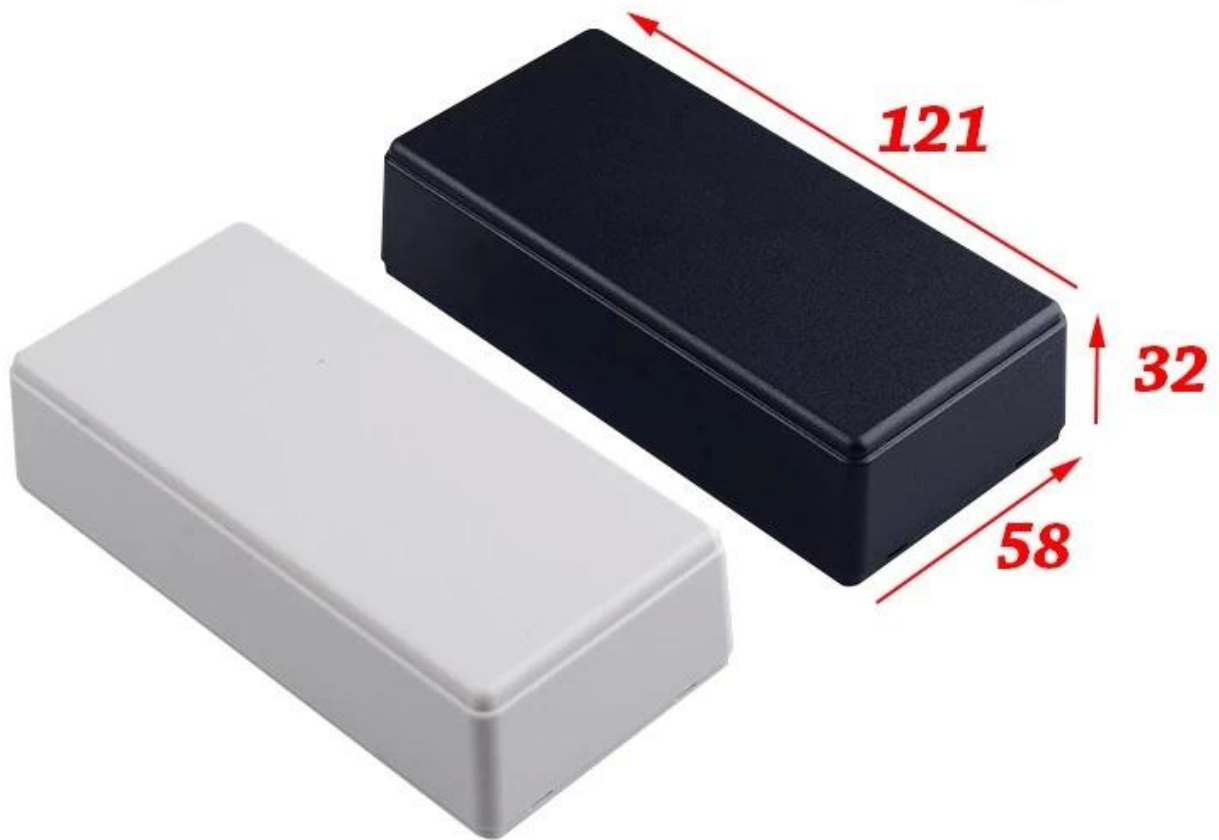

**Weight :56 g**

**Model No. AK-S-21** **121\*58\*32 mm**  
**Size:4.76\*2.28\*1.26 inch**

**SZOMK**



**SZOMK**



**SZOMK**



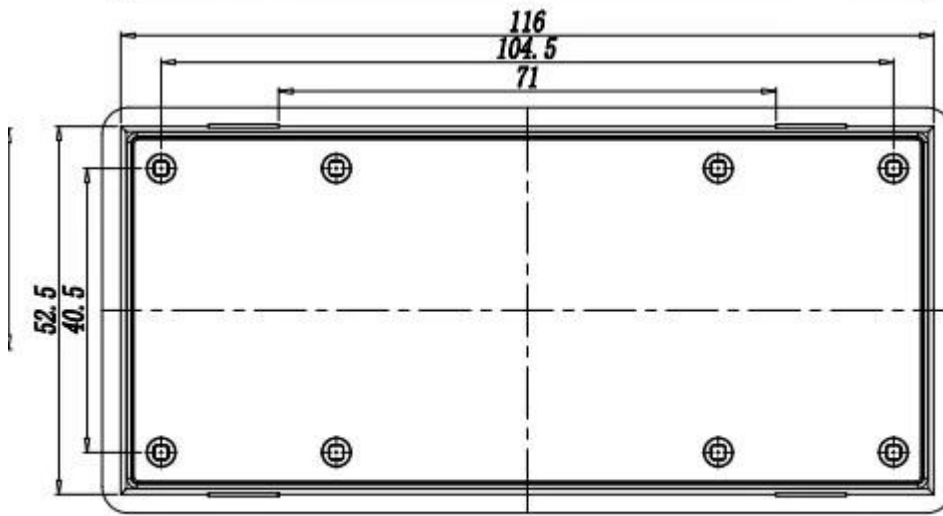
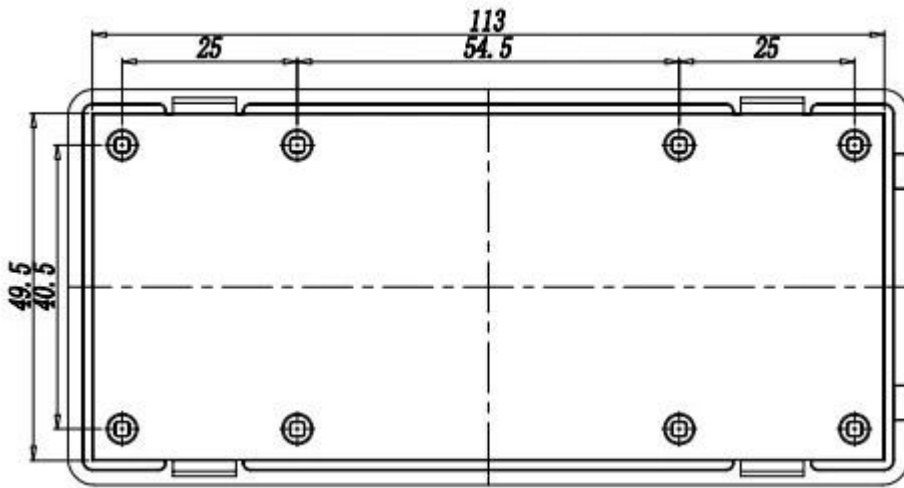

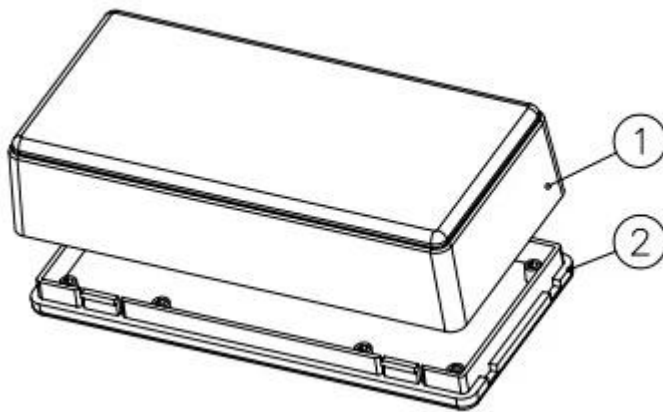
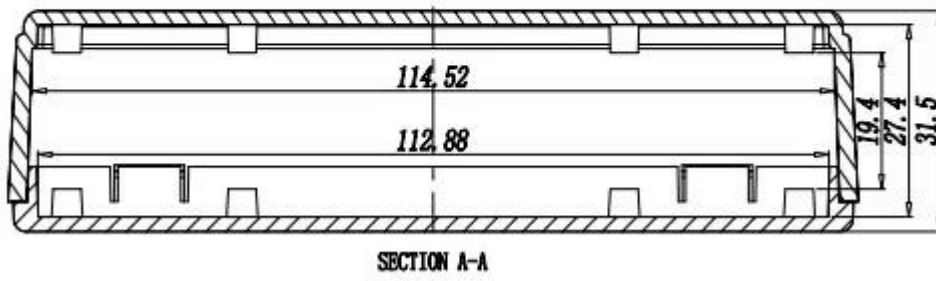
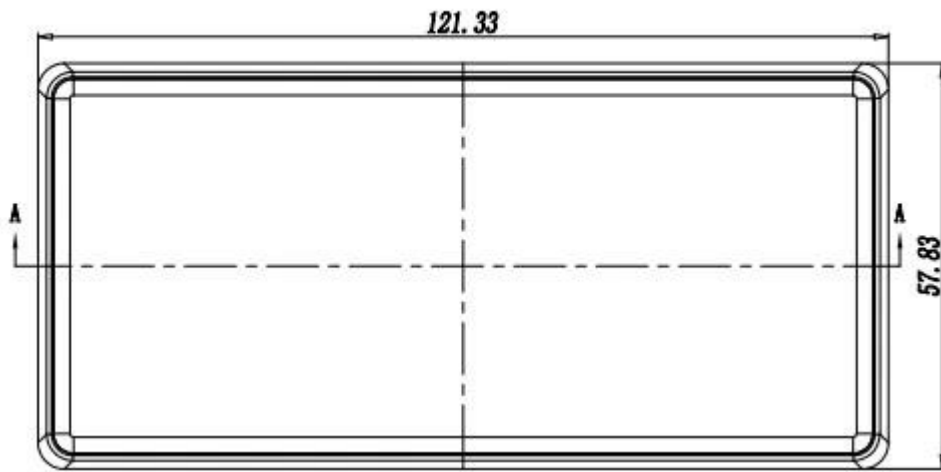



QQ

505924585



Tel

86-755-83222882  
86-13028816914



Add

628Room,505 Building ,Shangbu industry,  
Hangtian road ,Futian district ,Shenzhen,  
China,518031



Email

[lily@szomk.net](mailto:lily@szomk.net)



skype

szomk006