

Hier is onze aanpassen service:

- 1, verandering aluminium lengte
- 2, verandert de kleur van onze dozen
- 3, product polijsten
- 4, poedercoaten
- 5, geborsteld olie
- 6, cut-out
- 7, lasder graveren
- 8, PVC-label
- 9, acryl plaat
- 10, zeefdruk
- 11, maken sticker
- 12, silicagel randen
- 13, zandstralen
- 14, draadtrekken
- 15, UV-bescherming

Gebruik:

Het wordt veel gebruikt in de elektronica, instrumentatie, automatisering, communicatie, voeding verenigt, studentenprojecten, versterkers, gezondheidszorg apparatuur, test- en meetapparatuur, industriële controle, randapparatuur apparaten en interfaces, schakelkasten.

Let op:

Van harte welkom om ons te contacteren voor meer informatie en offertes van onze behuizing, zal uw aanvraag zeker krijgen prompt reactie in 24 uur: .-)

SZOMK



SZOMK



SZOMK

Customizable
Cutout, sticker
Silkscreen, color



Weight :271 g
Model No. AK-H-34

Size:6.81*3.35*1.97 inch
173*85*50 mm

SZOMK



SZOMK



SZOMK



SZOMK



SZOMK

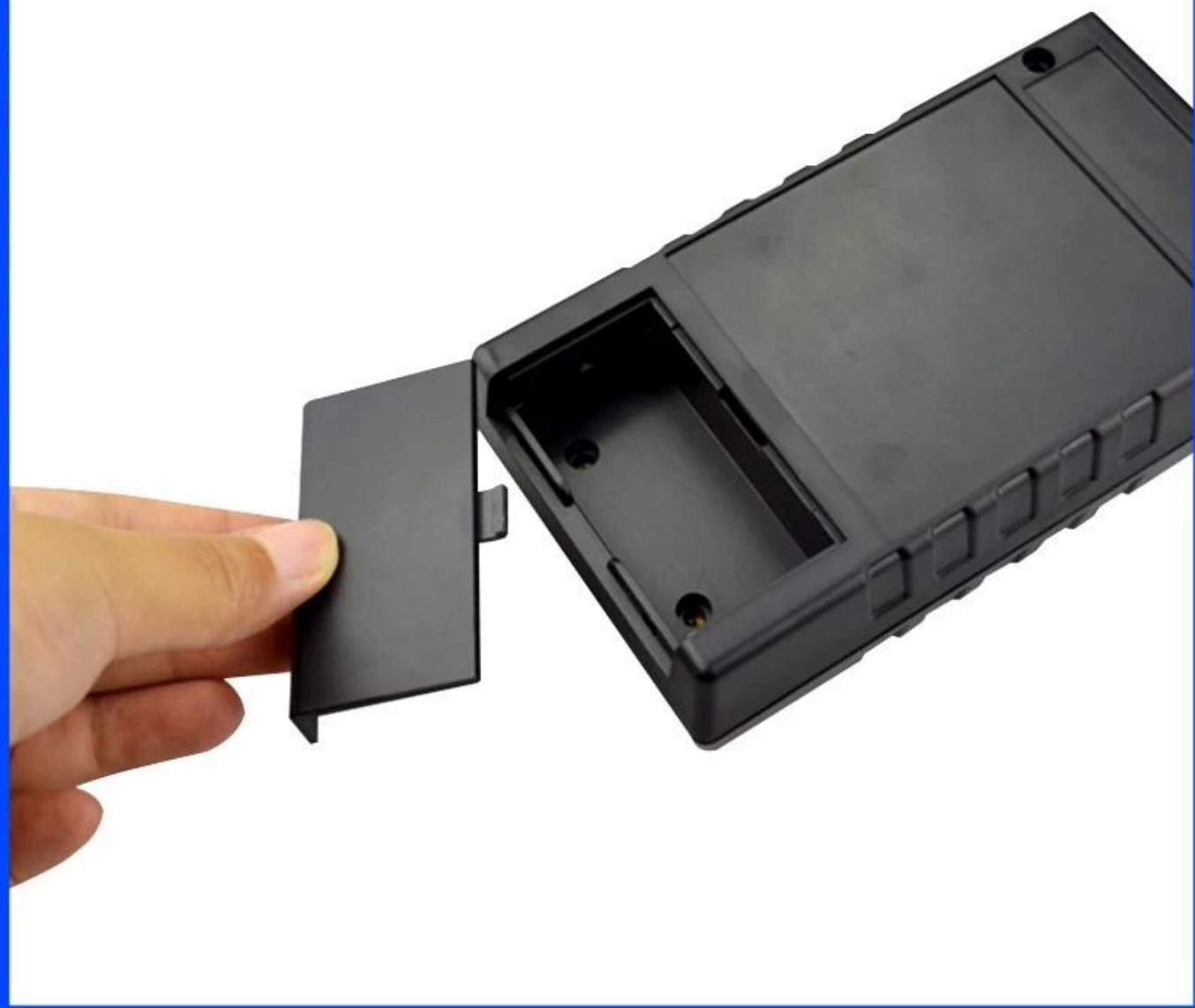

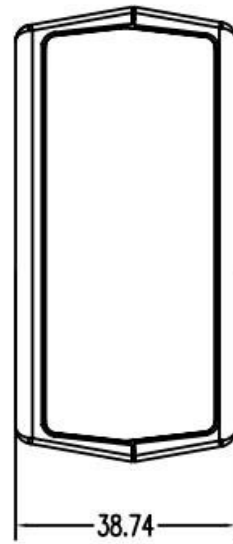
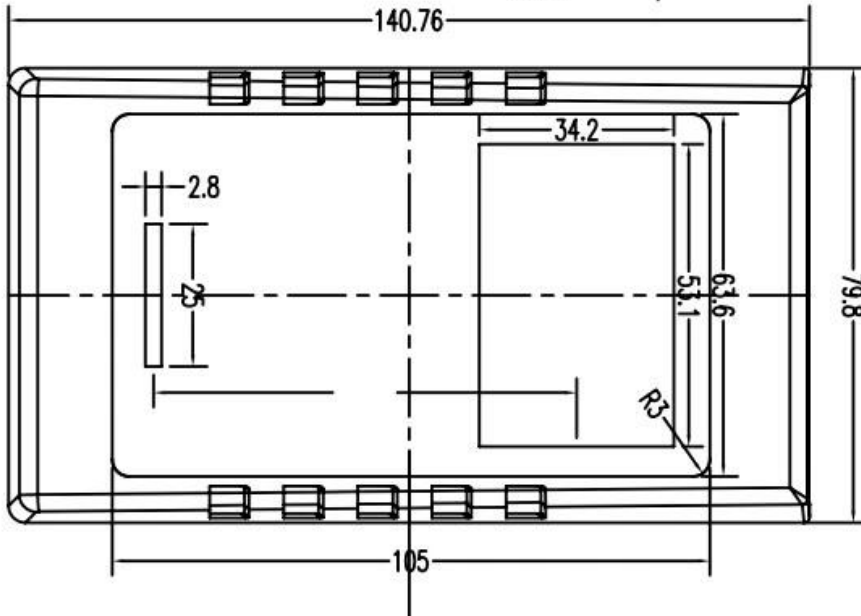
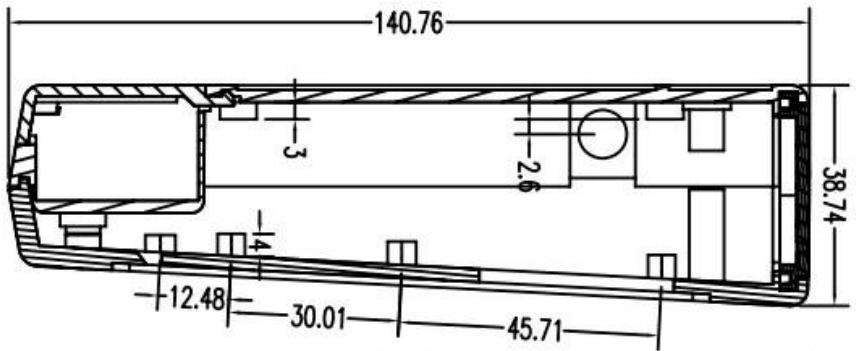

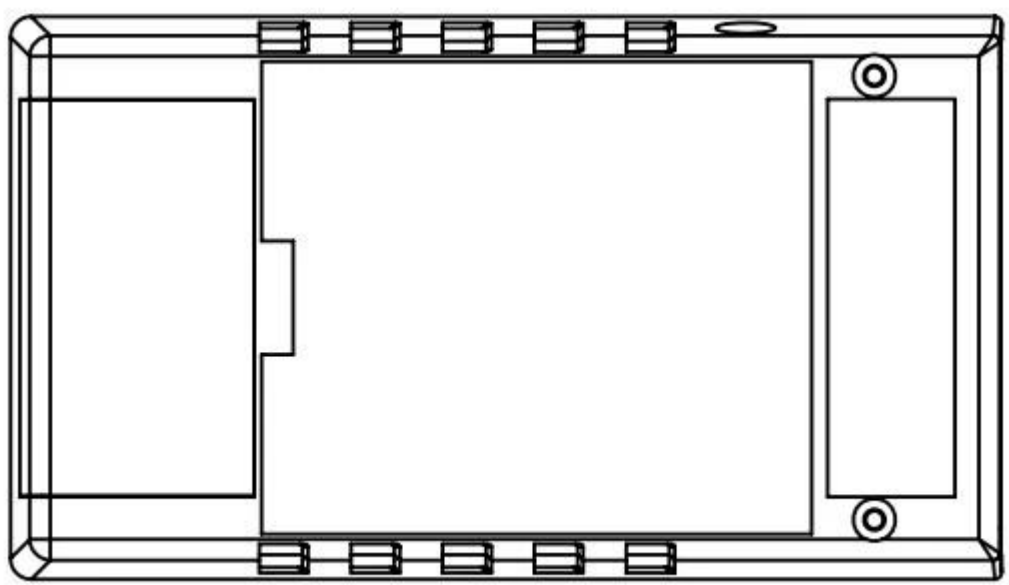
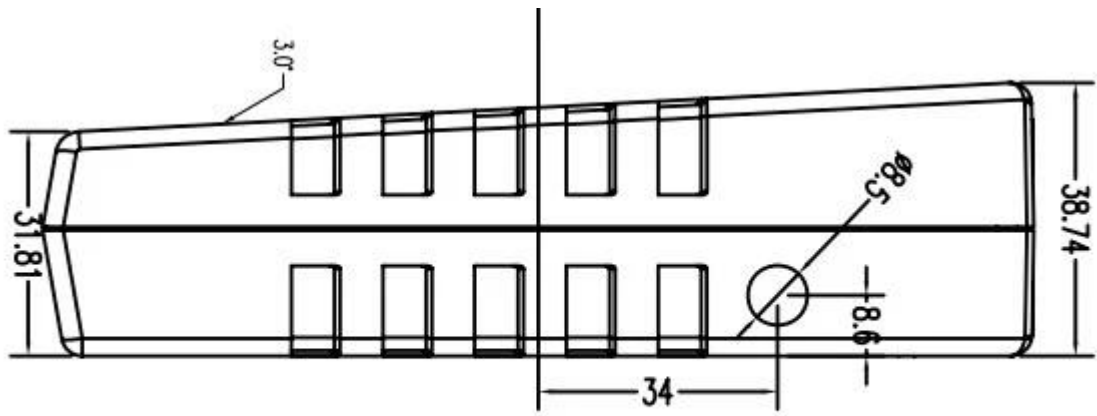

03

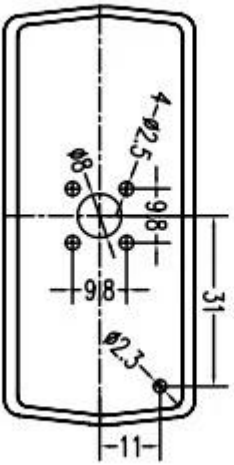

04

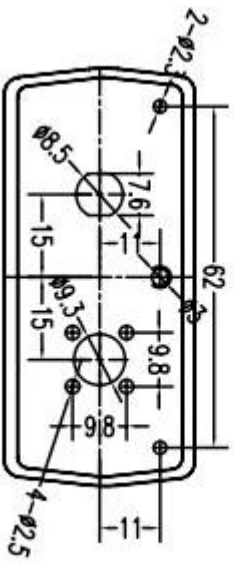

SEC 1-1

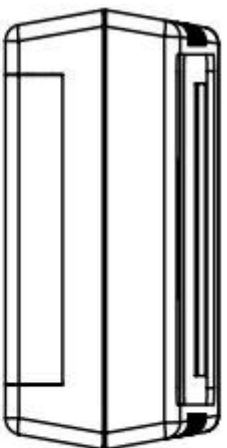

现有挡片开孔尺寸

01

正负公差



02

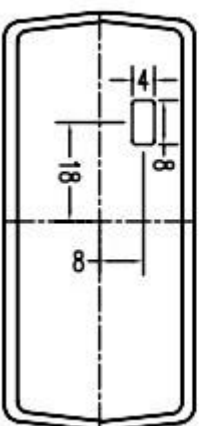



QQ

505924585



Tel

86-755-83222882
86-13028816914



Add

628Room,505 Building ,Shangbu industry,
Hangtian road ,Futian district ,Shenzhen,
China,518031



Email

lily@szomk.net



skype

szomk006