

Hier is onze aanpassen service:

1. Verander de lengte
2. Verander kleur
3. Polijsten
4. Zandstralen
5. geborsteld aluminium folie
6. Cut gat
7. Laser carve
8. PVC label
9. Acryl plaat
10. Scherm

Gebruik:

Het wordt veel gebruikt in de elektronica, instrumentatie, automatisering, communicatie, voeding verenigt, studentenprojecten, versterkers, gezondheidszorg apparatuur, test- en meetapparatuur, industriële controle, randapparatuur apparaten en interfaces, schakelkasten.

Let op:

Welkom om ons te contacteren voor meer informatie en offertes van onze behuizing, zal uw aanvraag zeker krijgen snelle reactie binnen 24 uur. :-)

SZOMK

**Customizable
Cutout, sticker
Silkscreen, color**

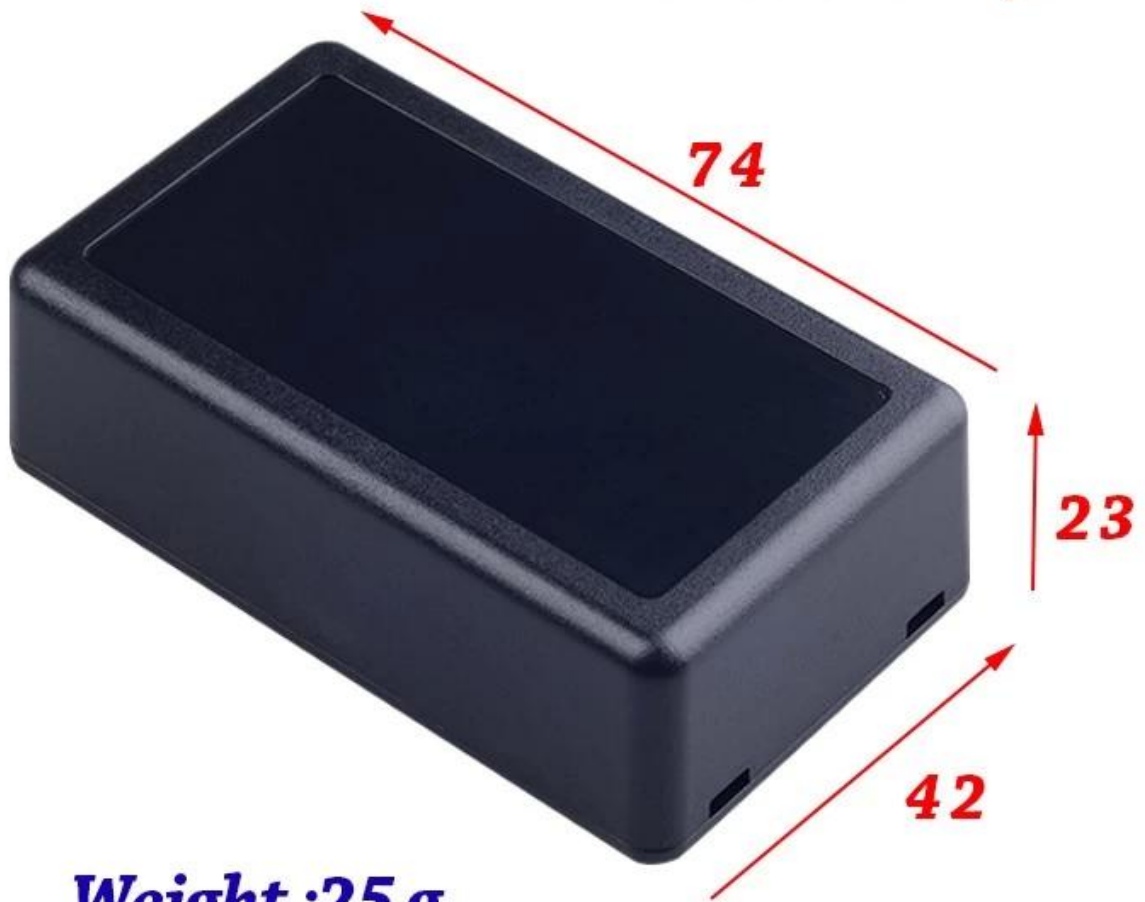

Weight :25 g

Model No. AK-S-15

74*42*23 mm

Size:2.91*1.65*0.91 inch

SZOMK



SZOMK



SZOMK



SZOMK



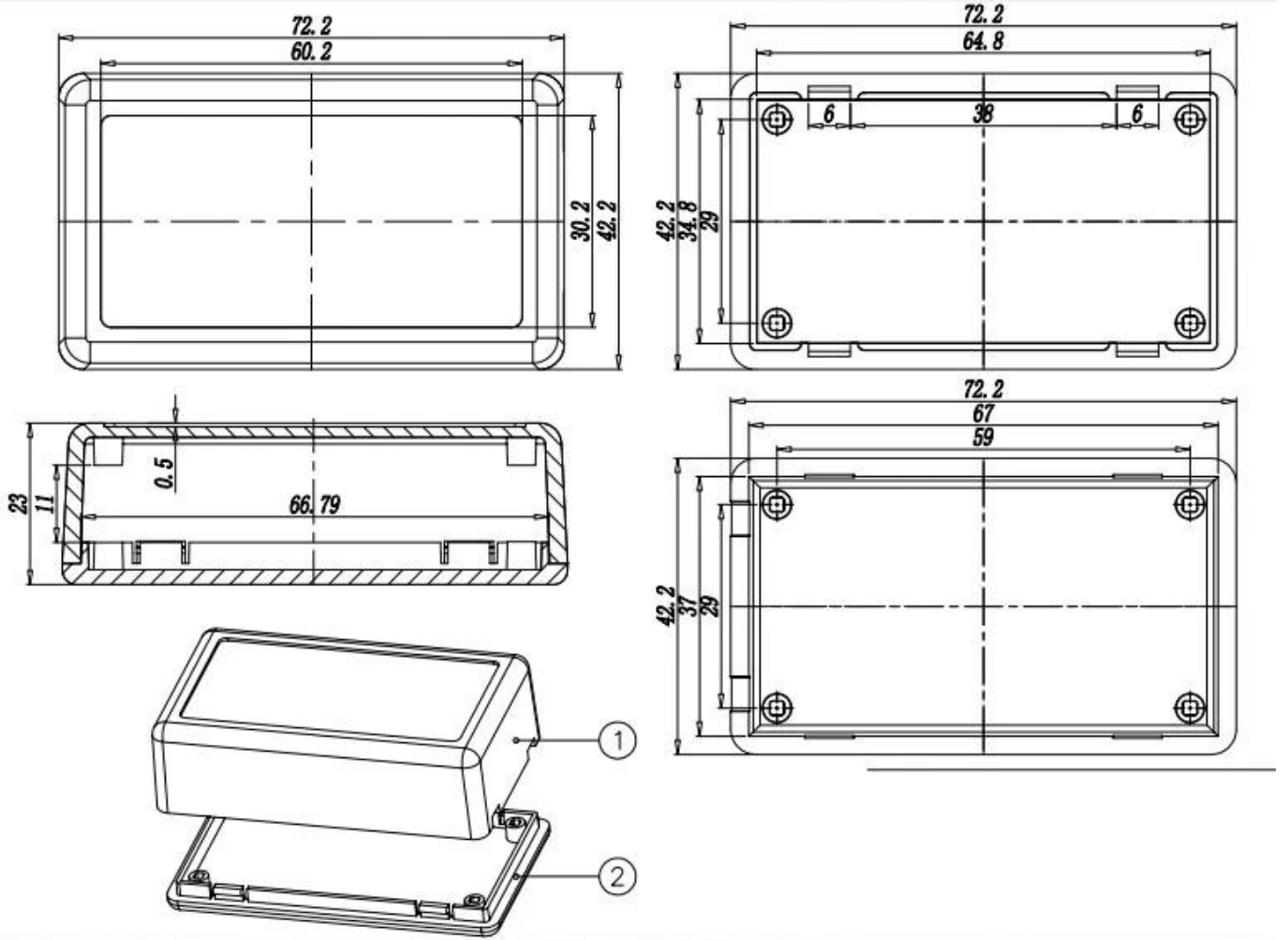



QQ

505924585



Tel

86-755-83222882
86-13028816914



Add

628Room,505 Building ,Shangbu industry,
Hangtian road ,Futian district ,Shenzhen,
China,518031



Email

lily@szomk.net



skype

szomk006