

Here is our customize service:

1. Change the length
2. Change color
3. Polishing
4. Sandblasting
5. Brushed aluminum foil
6. Cut hole
7. Laser carve
8. PVC label
9. Acrylic plate
10. Screen

Use:

It is widely used in electronics, instrumentation, automation, communication, power supply unites, student projects, amplifiers, healthcare equipment, test and measurement equipment, industrial control, peripherals devices and interfaces, switch boxes.

Attention:

Welcome to contact us for more details and quotations of our enclosure, your inquiry will surely get prompt response in 24 hours. :-)

SZOMK

**Customizable
Cutout, sticker
Silkscreen, color**

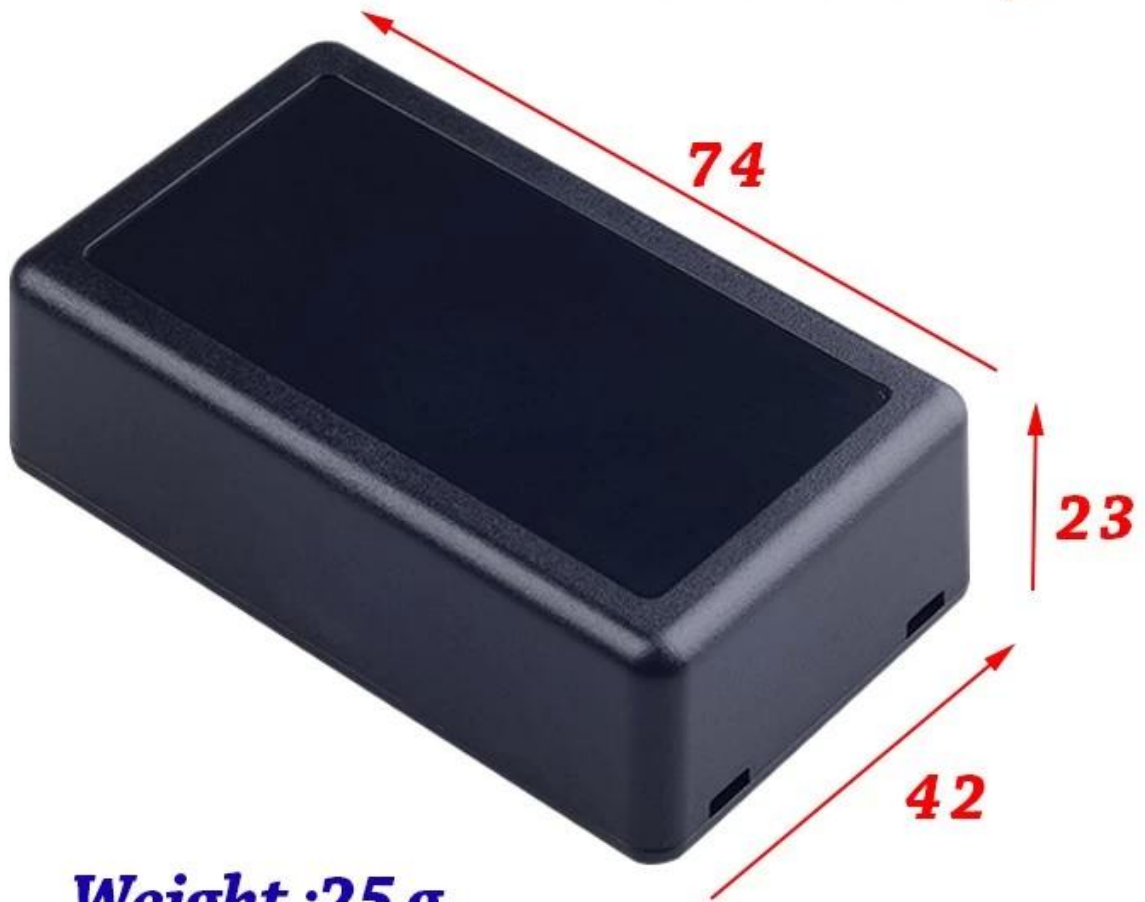

Weight :25 g

Model No. AK-S-15

74*42*23 mm

Size:2.91*1.65*0.91 inch

SZOMK



SZOMK



SZOMK



SZOMK



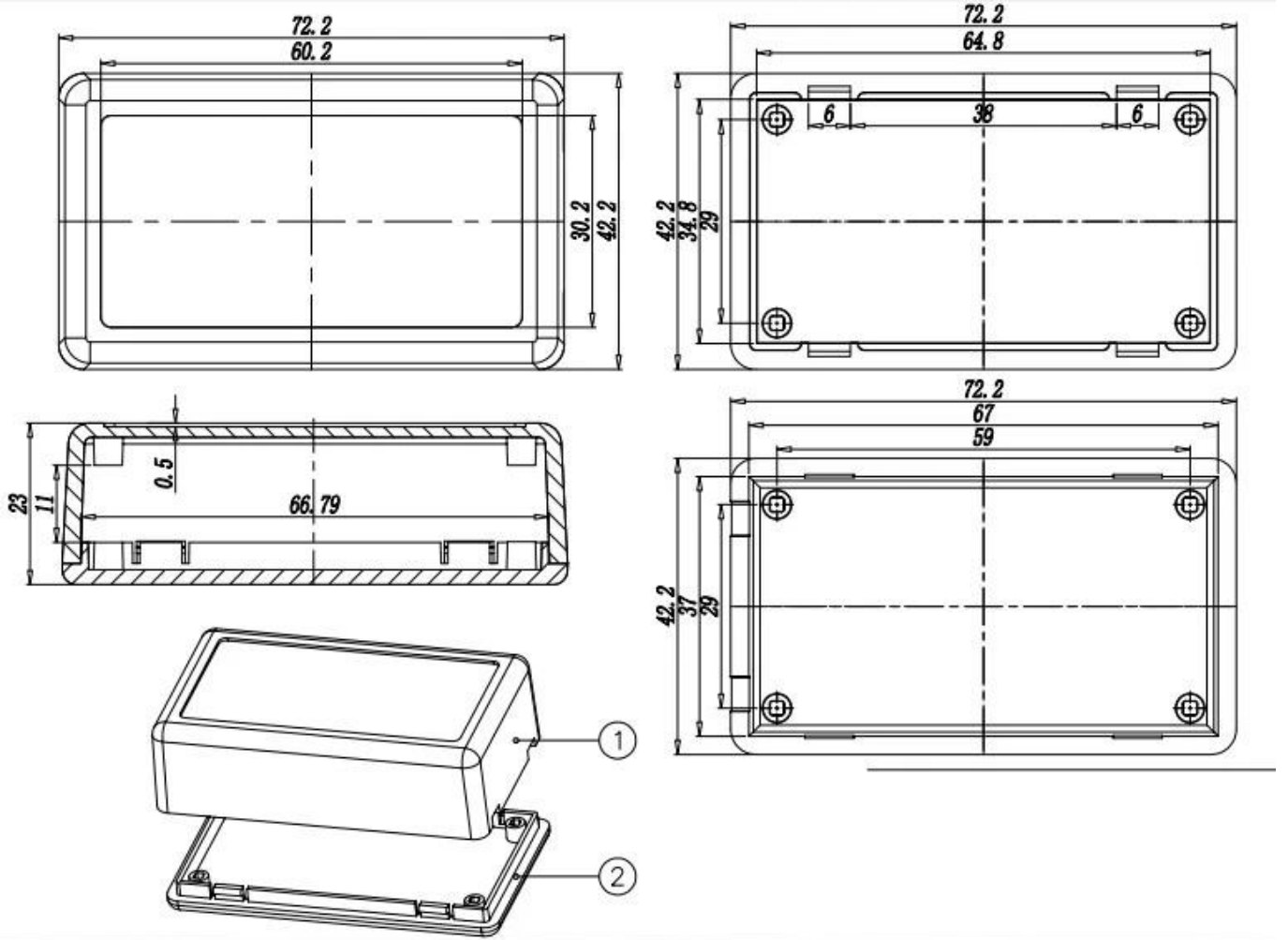



QQ

505924585



Tel

86-755-83222882
86-13028816914



Add

628Room,505 Building ,Shangbu industry,
Hangtian road ,Futian district ,Shenzhen,
China,518031



Email

lily@szomk.net



skype

szomk006