

## **Introdução para a caixa elétrica ao ar livre plástico:**

- 1 A utilização de um sachê de gel de sílica para a prova de água, que é altamente resistentes à água e altamente selado
- 2 O uso de parafusos de cobre e parafusos de aço inoxidável para o corpo externo
- 3 pregos e parafusos tapeçaria tapeçaria
- 4 parafusos de spots com suas capas
- Nível até 5 à prova de água para IP68
- 6 pacote exclusivo para cada unidade

## **Temos o prazer de lhe fornecer:**

- 1 de perfuração, perfuração, etc. Bem-vindo a fornecer desenhos personalizados.
- 2 Silkscreen, Laser Carve, adesivos, etc.
- 3 Prazo de execução curto, normalmente 3-5 dias após o pagamento (de acordo com a quantidade)
- 4 pronta resposta para a sua pergunta

## **Aplicações:**

É amplamente utilizado em eletrônica, instrumentação, automação, comunicações, unidades de fornecimento de energia, projetos de estudantes, amplificadores, dispositivos médicos e de bem-estar, teste e medição, controle industrial, dispositivos e interfaces periféricas, caixas de comutação.

## **Prompt Quente:**

Bem-vindo a contactar-nos para mais detalhes e citações para caixa elétrica, sua pergunta certamente irá receber pronta resposta em 24 horas!

## **Aqui estão mais imagens para caixa elétrica:**

**SZOMK**



**SZOMK**



# SZOMK

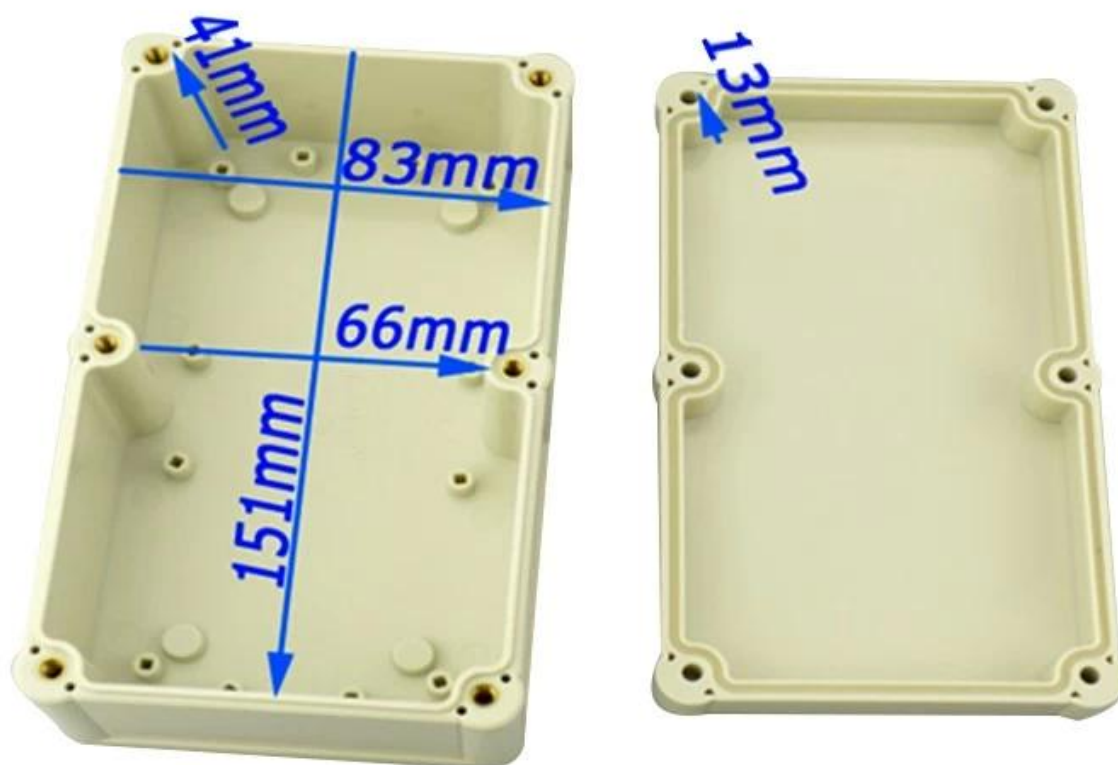

# SZOMK

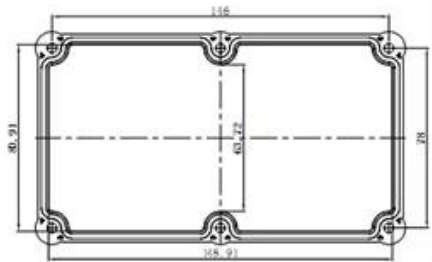
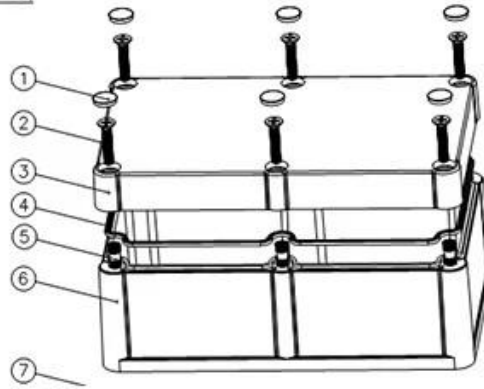
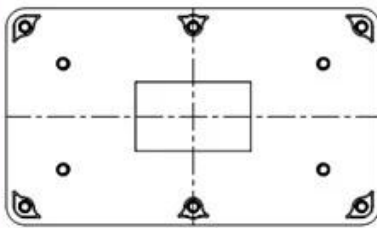
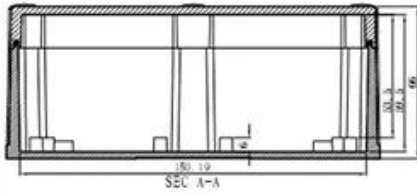
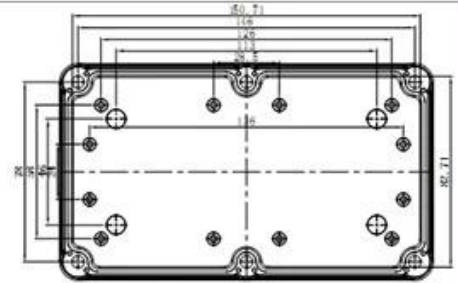
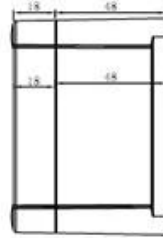
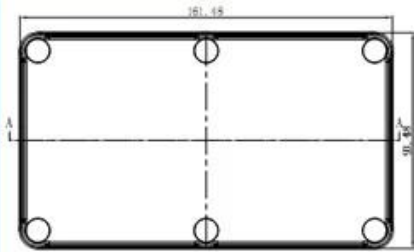

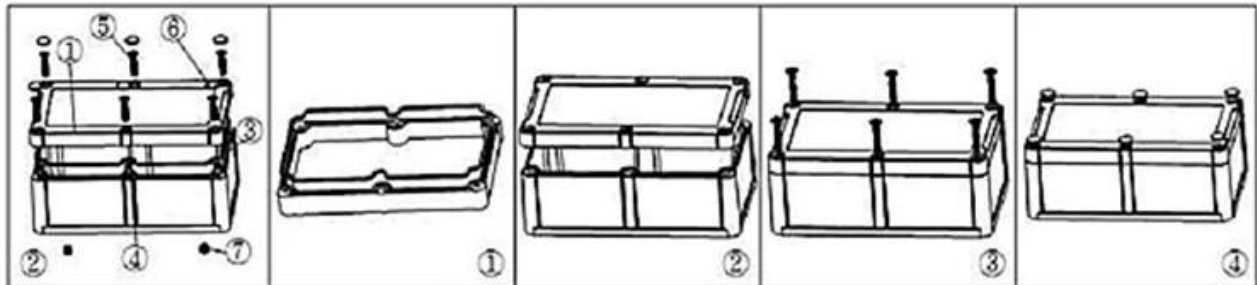

**Epitheca (1PCS)**  
Material:ABS  
Color:Light Grey(FS20412)



**Hypotheca (1PCS)**  
Material:ABS  
Color:Light Grey(FS20412)



**Gasket (1PCS)**  
Material:Rubber  
Size:113\*113\*1.8 mm



**Copper Nut(6PCS)**  
Material:Copper  
Standard:M4\*10  
Color:Copper



**Grub Screw(6PCS)**  
Material:Stainless Steel  
Standard:M4\*25



**Screw Lid(6PCS)**  
Material:ABS  
Color:Light Grey(FS20412)



**Self-Tapping Screw(4PCS)**  
Material:Iron  
Standard:M4\*30



**Copper Nut(4PCS)**  
Material:M4\*5  
Color:Copper



QQ

2819022460



Tel

86-755-83222882  
86-13418600500



Add

628Room,505 Building ,Shangbu industry,  
Hangtian road ,Futian district ,Shenzhen,  
China,518031



Email

[hellen@szomk.com.cn](mailto:hellen@szomk.com.cn)



skype

szomk-002

