

It is widely used in electronic, instrumentation, automation, communications, power supply units, student projects, amplifiers, Medical and wellness devices, test and measurement equipment, industrial control, peripheral devices and interfaces, switch boxes.



Vantagens da caixa de distribuição eletrônica de caixa de plástico abs

1. Tem uma forte resistência à abrasão, intempéries, corrosão.
2. Pode ser formado na superfície de uma variedade de cores, para maximizar o ajuste de suas necessidades.
3. Tem uma dureza forte, pode ser bem protegido seus eletrônicos.

O que nós podemos fazer por você

- 1 Drilling, Punching, etc. Bem-vindo a fornecer desenhos personalizados.
- 2 Revestimento em pó, escova, polonês, serigrafia, Laser Carve, adesivo, gravura, folha de acrílico.
- 3 prazo de entrega curto, normalmente 3-5 dias após o pagamento (de acordo com a quantidade)
- 4 pronta resposta para sua pergunta

Imagens detalhadas da caixa de distribuição eletrônica de caixa de plástico abs

SZOMK



▶ **Enclosure Manufacturer**
www.chinaenclosure.com

SZOMK

Customizable
cutout, sticker
silkscreen, color



Weight: 52g
Model No. AK-S-03

Size: 4.33*2.56*1.10 inch
110*65*28 mm

Desenhos detalhados

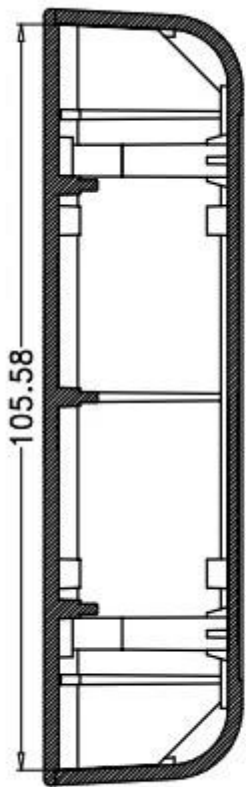

SECTION B-B

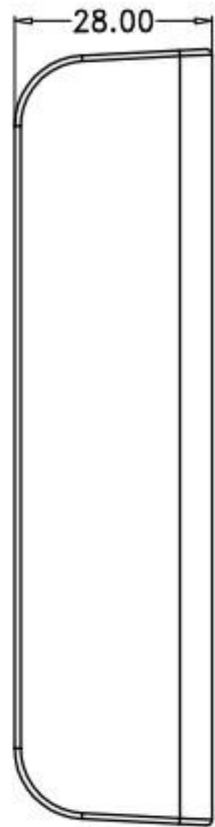
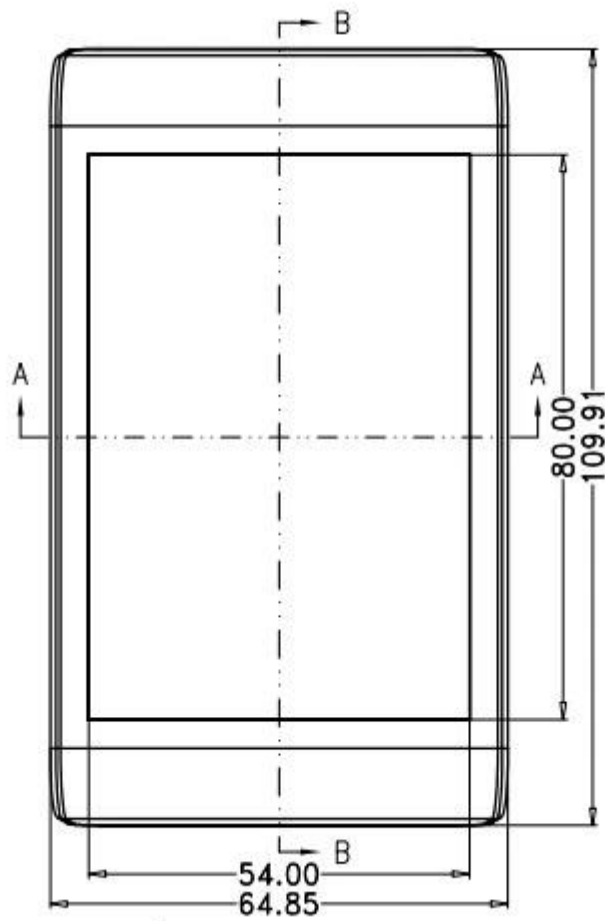

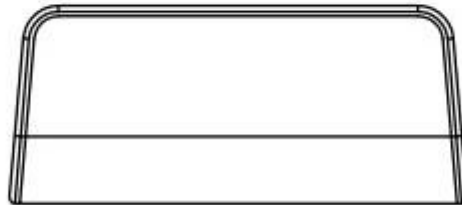
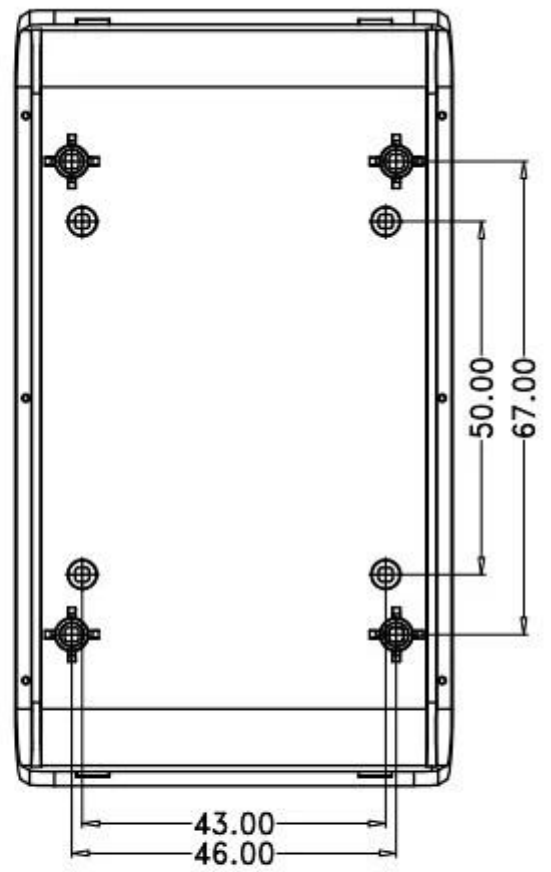
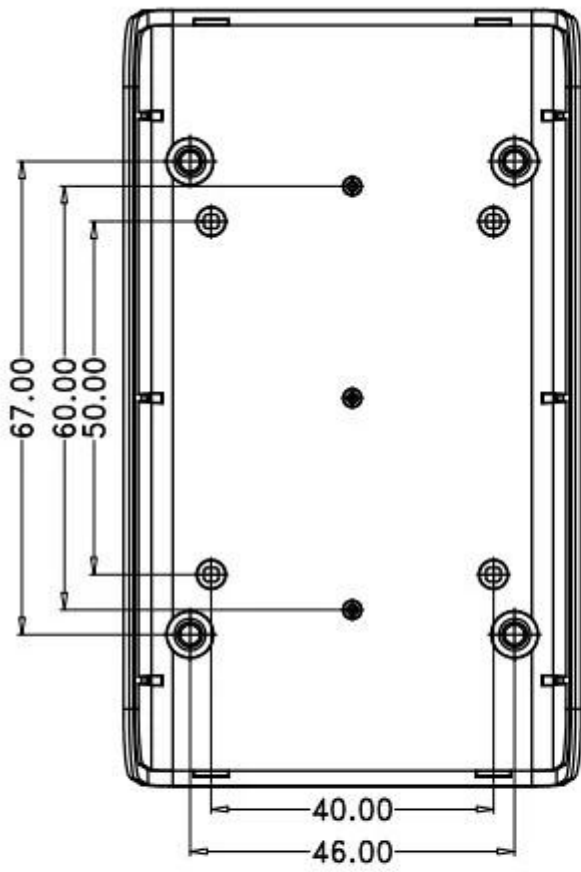

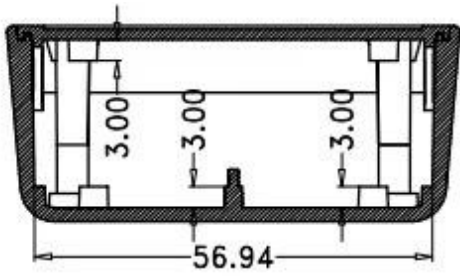

SECTION A-A

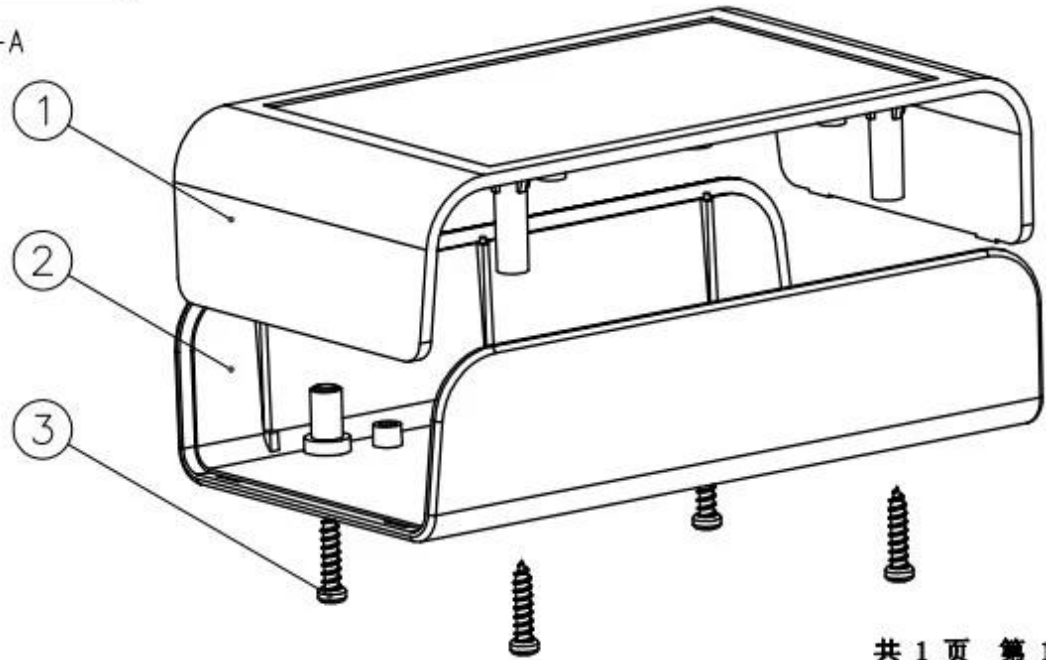

Outra personalização



SZOMK

WE CAN DO

- Provide thousands of public enclosure**
MOQ: 1 piece
- Small order custom** MOQ: 20-30 pcs
- Design private custom enclosure (provide PCB)**
- Molding, tooling (provide sample / STEP file)**







cutout, laser engrave, screen printing, sticker, acrylic plate, pvc label, color, silica gel rings, etc.



WE CAN DO
For HOUSING some of the Processing,
Openings, Screen, Stickers, PVC LABEL

The image features a man in a dark polo shirt working in a workshop. To his right, a text overlay reads "WE CAN DO" in large, bold, black letters, followed by "For HOUSING some of the Processing, Openings, Screen, Stickers, PVC LABEL" in smaller, white, bold letters. Below the text are three small inset images: the first shows a yellow metal box with a hand opening a drawer; the second shows a hand holding a black electronic device; the third shows a hand holding a small electronic component with a green LED and a black antenna.

Embalagem e métodos de envio



Our packaging

Plastic foam packaging



Metal shell packaging

Plastic box packaging



Packaging & Shipping



Contate-Nos



Email

jamila@szomk.com.cn



skype

szomk-004



Tel

86-755-83222882

86-18684887280



QQ

2804842423



WhatsApp

86-18684887280



Add

616Room,505 Building ,Shangbu industry,
Hangtian road ,Futian district ,Shenzhen,
China,518031