

Aqui é o nosso serviço da personalização:

1. Alterar o comprimento
2. Mude a cor
3. Polimento
4. Jateamento
5. escovado folha de alumínio
6. Corte buraco
- Carve 7. Laser
8. rótulo PVC
9. placa de acrílico
10. Tela

Use:

É amplamente utilizado em eletrônica, instrumentação, automação, comunicação, reúne de fornecimento de energia, projetos de estudantes, amplificadores, equipamentos de saúde, teste e medição, controle industrial, dispositivos e interfaces periféricos, caixas de comutação.

Atenção:

Bem-vindo a contactar-nos para mais detalhes e citações do nosso gabinete, sua pergunta certamente irá receber pronta resposta em 24 horas. :-)

SZOMK

**Customizable
Cutout, sticker
Silkscreen, color**

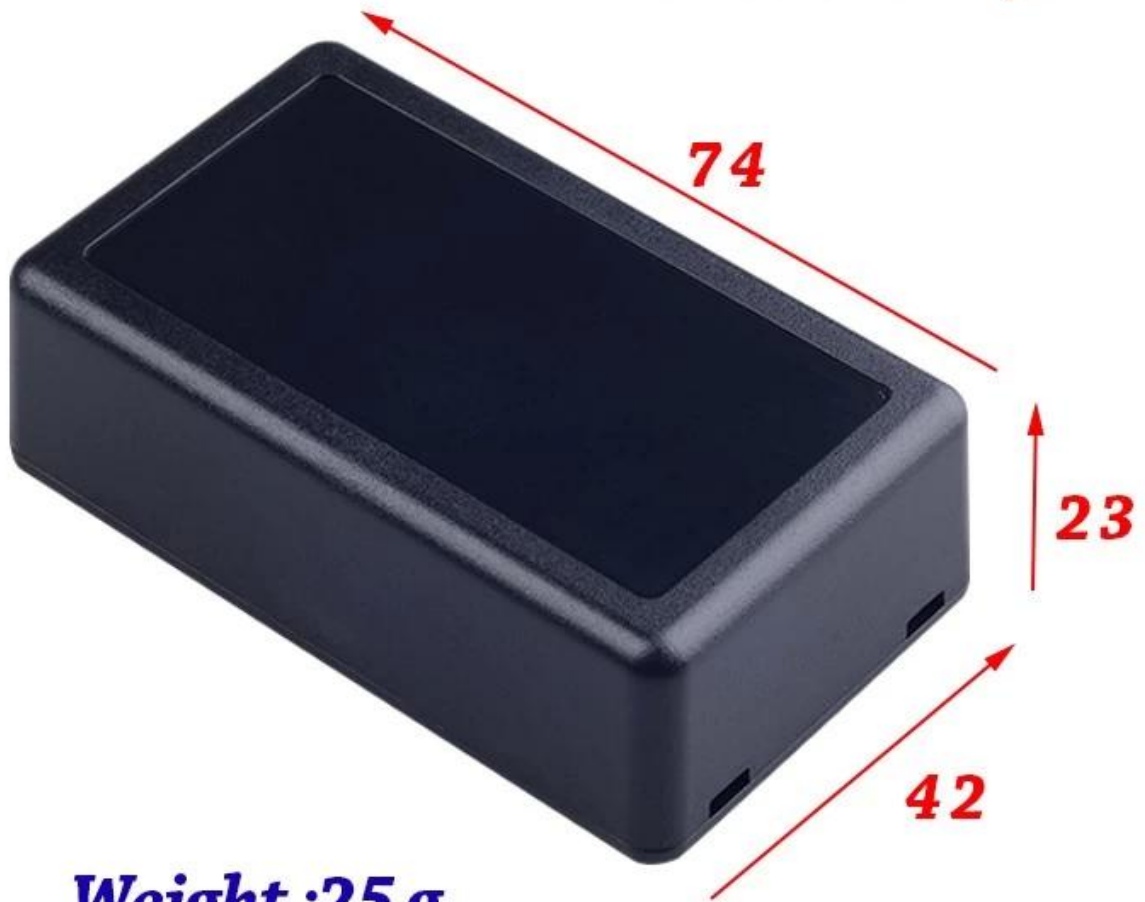

Weight :25 g

Model No. AK-S-15

74*42*23 mm

Size :2.91*1.65*0.91 inch

SZOMK



SZOMK



SZOMK



SZOMK



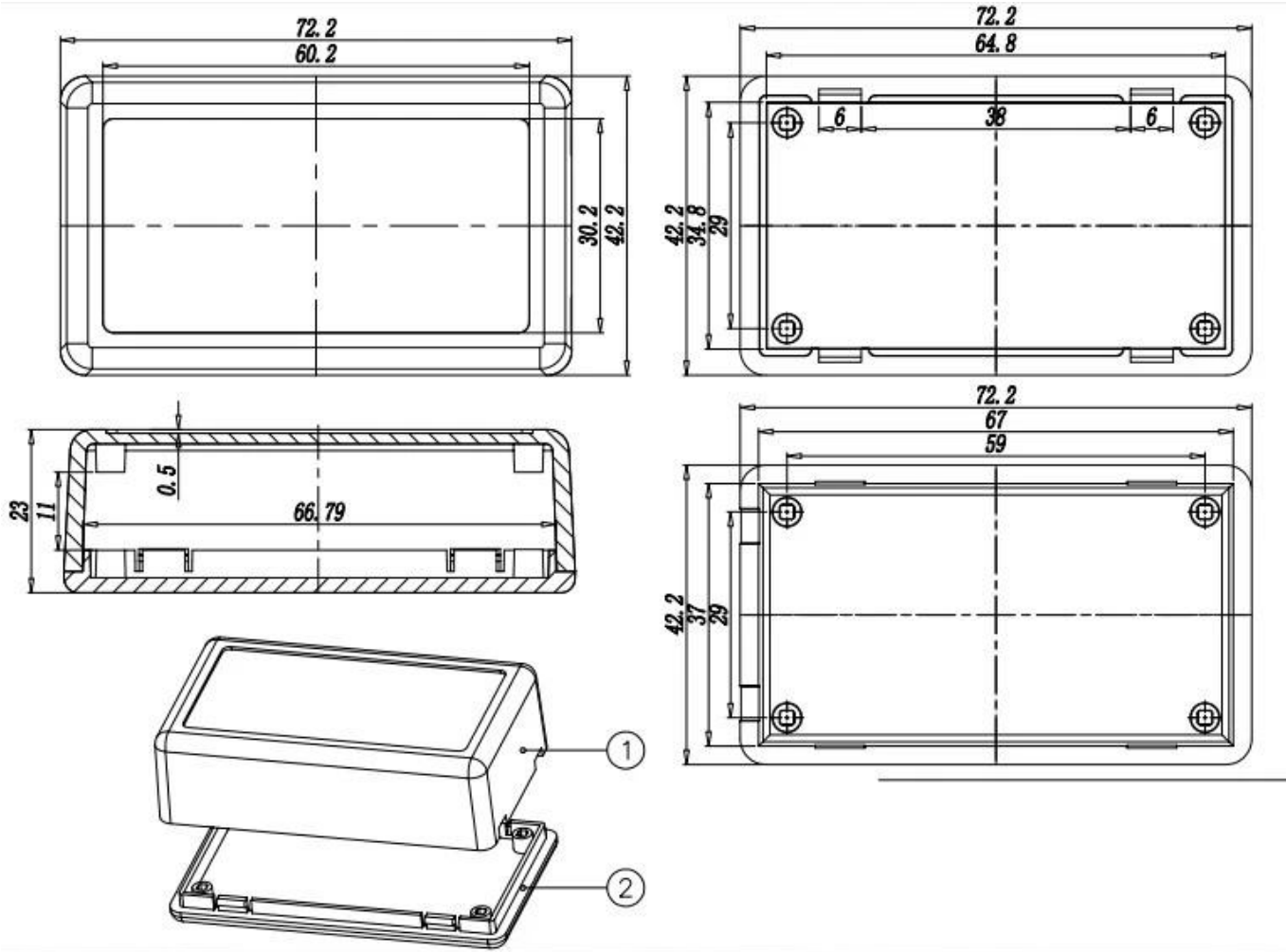



QQ

505924585



Tel

86-755-83222882
86-13028816914



Add

628Room,505 Building ,Shangbu industry,
Hangtian road ,Futian district ,Shenzhen,
China,518031



Email

lily@szomk.net



skype

szomk006