

Описание продукта:

1. Номер модели: АК-S-03
2. Размер: 110x65x28mm
3. Цвет: A1, A2, A6, A8, A9, A11
4. Вес: 52g



SZOMK

**Customizable
Cutout, sticker
Silkscreen, color**



Weight :52 g

Model No. AK-S-03

110*65*28 mm

Size:4.33*2.56*1.10 inch

SZOMK

**Customizable
Cutout, sticker
Silkscreen, color**

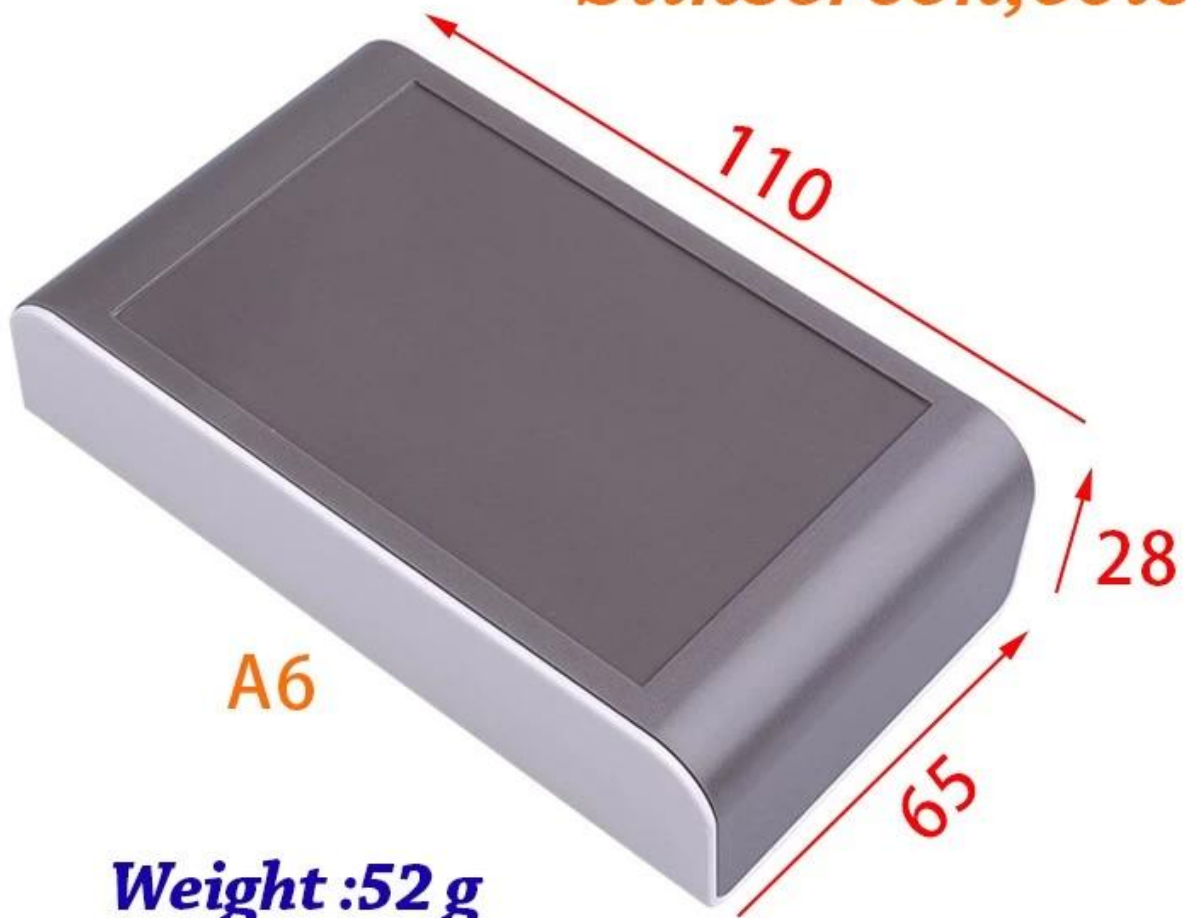

A6

Weight :52 g

Model No. AK-S-03

110*65*28 mm

Size:4.33*2.56*1.10 inch

SZOMK

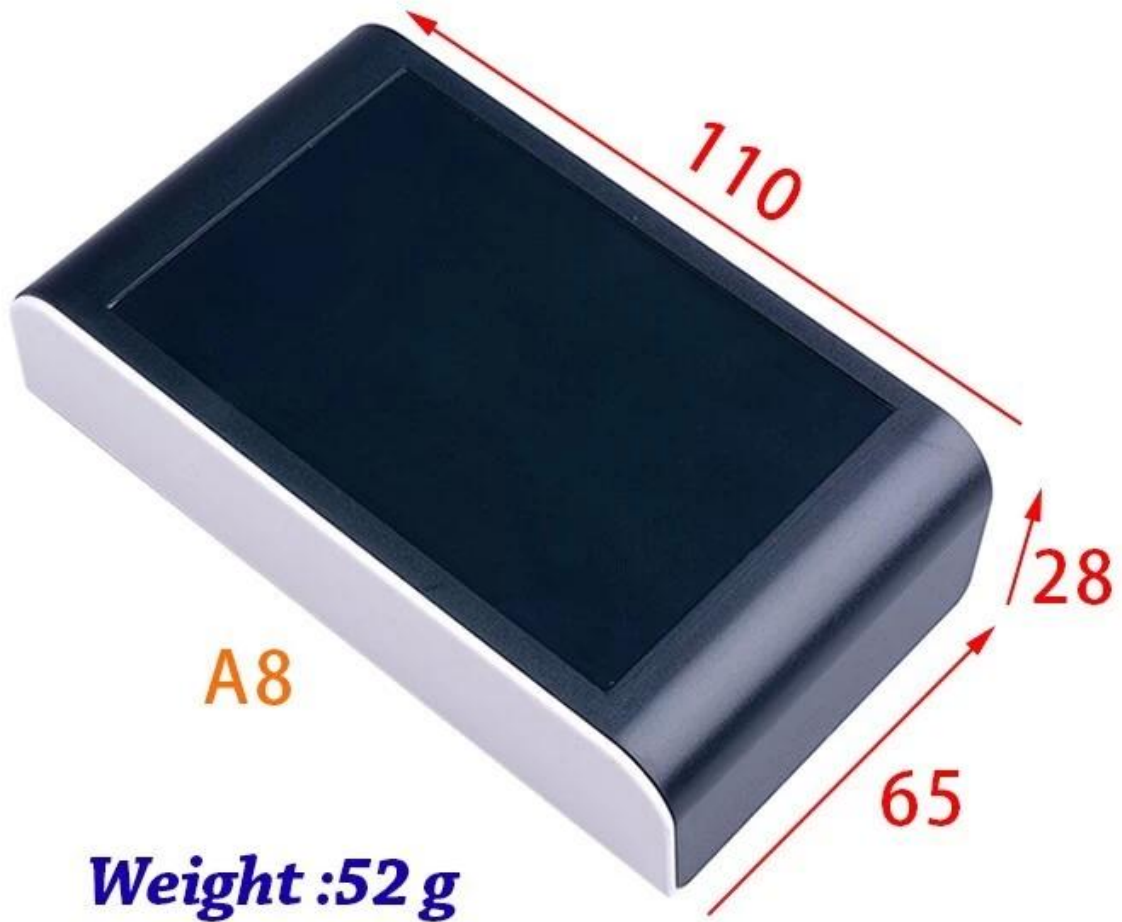

A8

Weight :52 g

Model No. AK-S-03

110*65*28 mm

Size:4.33*2.56*1.10 inch

SZOMK

**Customizable
Cutout, sticker
Silkscreen, color**



A9

Weight :52 g

Model No. AK-S-03

110*65*28 mm

Size:4.33*2.56*1.10 inch

SZOMK

**Customizable
Cutout, sticker
Silkscreen, color**



Weight :52 g

Model No. AK-S-03

110*65*28 mm

Size:4.33*2.56*1.10 inch

SZOMK



SZOMK



SZOMK



SZOMK

A9

A11

A8



A1

A2

A6

SZOMK



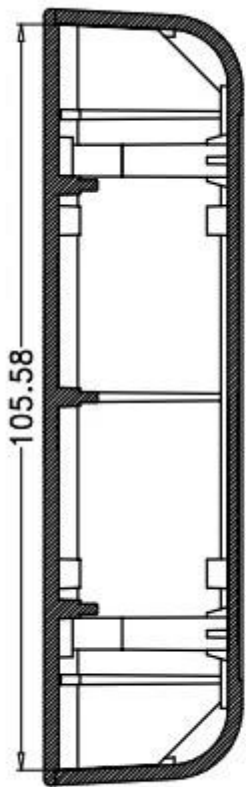

SECTION B-B

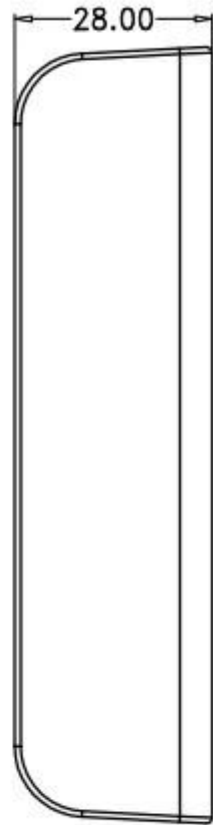
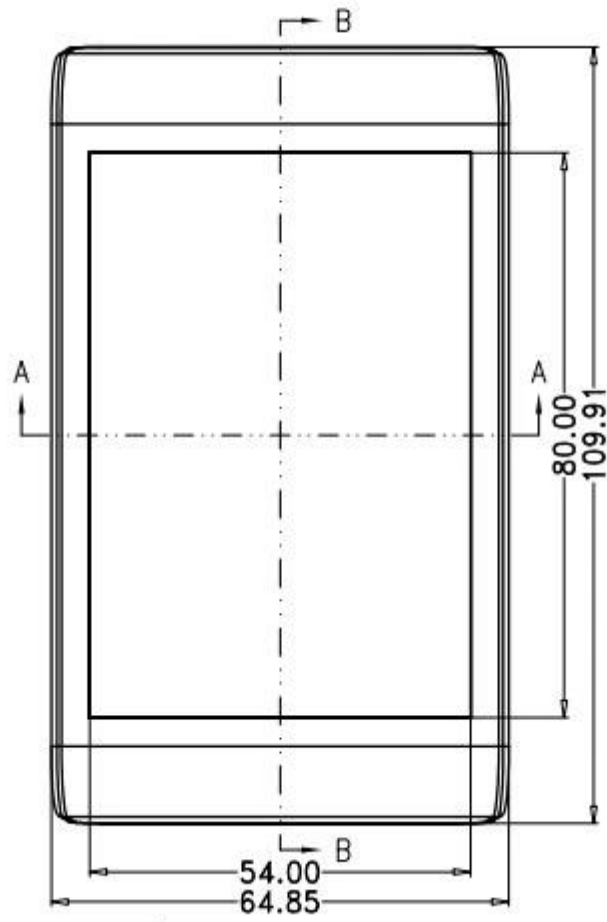

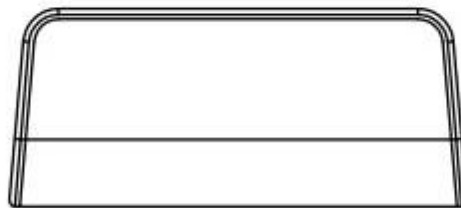
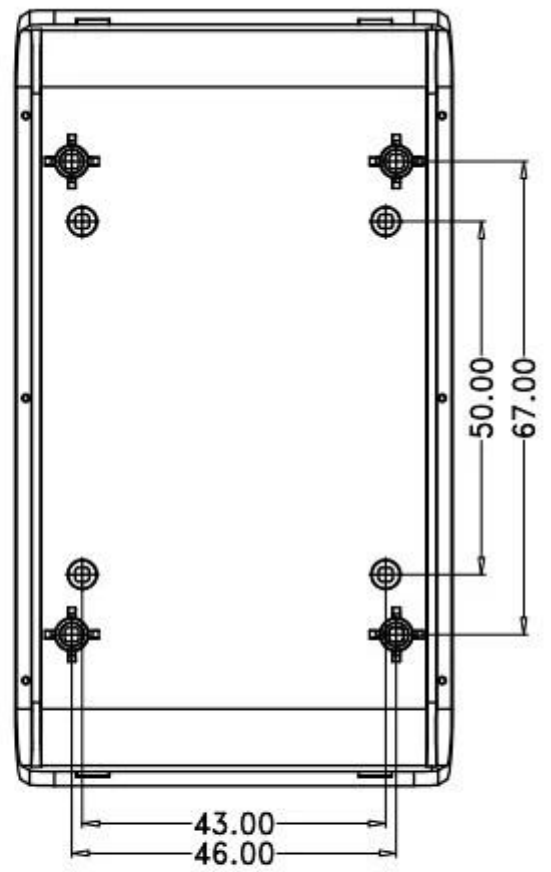
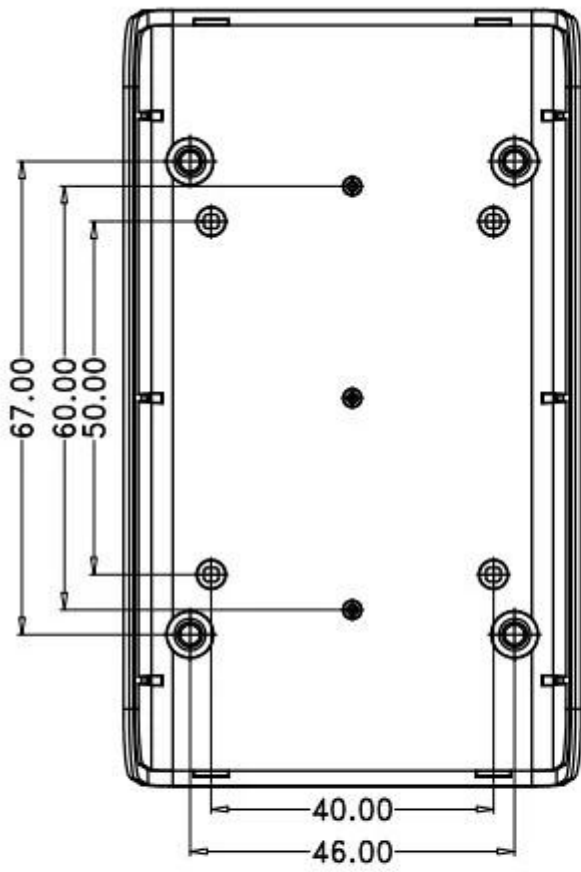

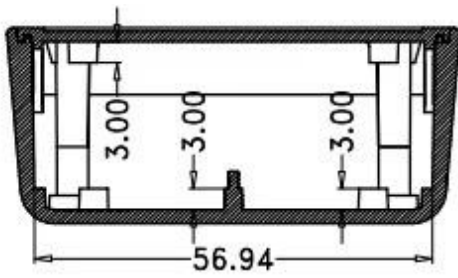

SECTION A-A

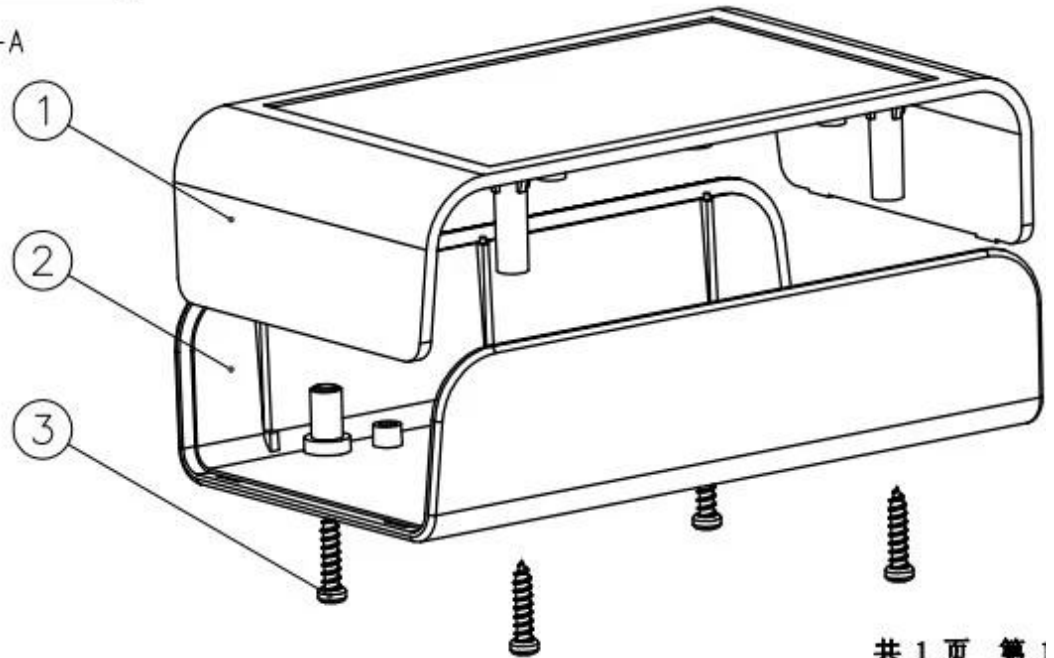

共 1 页 第 1

Наша настроены службы:

1. Изменение длины
2. Изменение цвета
3. Полировка
4. Нанесение порошковых покрытий
5. Матовый алюминий фольга
6. Просверлите отверстия
7. Лазерная гравировка
8. этикетка ПВХ
9. Акриловые пластины
- Экран 10.Silk

Company Information



Shenzhen Futian Huaqiang Electronic World OMK Electronic Sales Department

This complex, during long years of efforts with its own experienced group and sole facilities for improvement of productions and promotion of products quality, is now one of the largest suppliers of all kinds of metallic and plastic enclosures in different fields of electronic, electrical, communication, medical, industrial and research projects purposes.

In today's industrial world and with the rapid development of all industries, the need of these products is sensed more than ever. Therefore by offering the best quality and service, we try to meet these needs and help you to reach your ideals.

Exhibition



Certificate



Factory and showroom



Packaging & Shipping



SZOMK

Shenzhen Futian Huaqiang Electronic World OMK Electronic Sales Department

Tel: +86-755-83222882 E-mail: ivy@szomk.com.cn



